

The World of Soldering

Soldering can be found everywhere. Soldering, also known as heat fusion, is a manufacturing process and technique for joining metals or other thermoplastic materials such as plastics in a heated, high temperature or high pressure manner.

Metal soldering is divided into three major categories: melting soldering, bonding and soldering according to the characteristics of its technical process. Soldering refers to a soldering method in which a solder and a soldering parts below the melting point of the soldering parts are simultaneously heated to the melting temperature of the solder, and then the gap between the solid work pieces is filled with the liquid solder to connect the metals.

The soldering is divided into hard and soft soldering. The melting point of the hard solder is above 450 ° C. The commonly used solders are a copper-based, silver-based, aluminum-based and nickel-based alloys and others. The melting point of soft solder is below 450 ° C. The most widely used soft solder is tin-based alloy. The soldering temperature of most soft solders is between 200 to 400 ° C. The soldering flux is rosin or scaling powder. The heating method is usually heating by soldering iron. This type of soldering is called soft soldering.

Tin soldering is a soft soldering.

Get ready, let's set off and head to the world of Soldering!

Contents



INTELLIGENT SOLDERING
01~32



FUME EXTRACTOR
33~44



DESOLDERING & REWORK
45~64



ESD PROTECTION
65~82



TESTER
83~90

SOLDERING STATION



- Quick thermal recovery
- 智能功率 Smart power
- Preset temperature
- Touch switch
- ESD detection
- Auto Sleep
- Password Lock
- Auto Shutdown
- °C/°F
- power-off protection
- Ergonomic
- Automatic recognition
- Software power switch
- Ultra-low power consumption 0.8W

QUICK TSI200



Intelligent network management: perfect combination of data traceability and process management

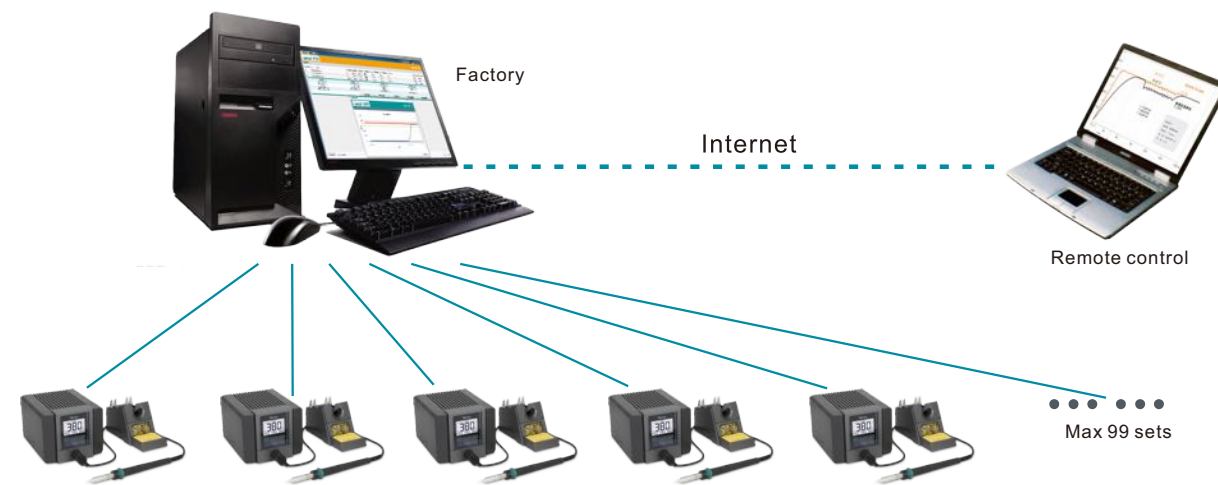

- Quick thermal recovery**: The sensor is placed at the top of the heating element, and the temperature can rise to the set value at an extremely high speed with accurate temperature control.
- Smart power**: The output power is intelligently distributed as the size of the soldered joint changes, and the maximum power can reach 120W.
- Preset temperature**: Quickly switch between 3 different temperature points to meet different soldering process requirements of different products.
- Touch switch**: The touch buttons are beautiful in appearance, waterproof and moisture-proof, easy to operate, and have a long life.
- ESD detection**: Real-time monitoring of ESD grounding to ensure electrostatic protection of soldered products.
- Auto Sleep**: Intelligent induction handle is designed with touch-type instant sleep function.
- Password Lock**: The password lock function effectively protects the production process parameters from being modified at will.
- Auto Shutdown**: Automatic shutdown function reduces consumable costs and saves energy.
- °C/°F**: Two temperature modes of Fahrenheit and Celsius temperature are free to switch.
- power-off protection**: The more intimate safety protection design, in response to a sudden power failure restart, will not self-heat without confirmation, so as to ensure safety.
- Ergonomic**: The soldering pencil is shortened in length, more ergonomic and comfortable to use, and better for precision welding.
- Zoned heating**: The temperature can be set for segmented heating, and the special devices are preheated first and then soldered, which is safe and effective.
- Automatic recognition**: Automatic recognition design, will prompt the alarm when the handle does not match the host machine.
- Software power switch**: POWER software switch, with a small standby power, and without useless work.
- Ultra-low power consumption**: 0.8W

SOLDERING STATION

SOLDERING STATION

QUICK TS1200 Performance test

- ▲ Heating rate test
- Rise from room temperature to 350 °C in just 8 seconds

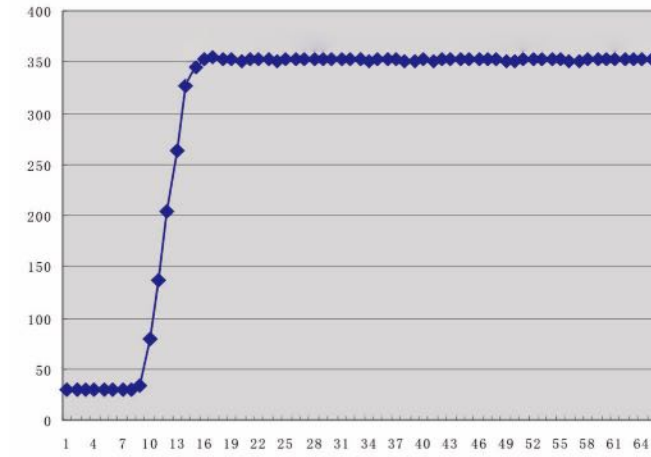

Tester	FLUKE2625A
Soldering tip	TSS02-B
Temperature sensor	K Type (Tested at approximately 1.5 mm from the soldering tip)

Soldered joints	10
Soldering tip	TSS02-B
Soldering temperature	375°C
Solder wire	Alpha SAC305(96.5%Sn 3%Ag 0.5%Cu)
Diameter of solder wire	ø1.0mm
Amount of solder	30mm for each joint

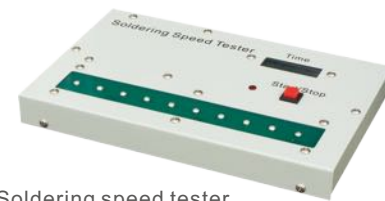

Soldering speed tester

- ▲ Continuous soldering capacity test
- Soldering 10 soldered joints takes 36 seconds

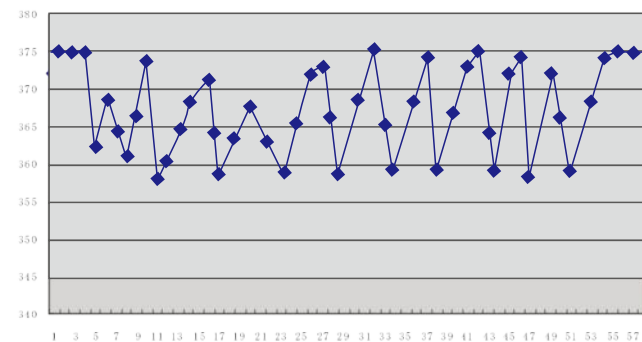

- ▲ Temperature recovery test (drag soldering)
- Soldering maximum temperature drops to 12°C
- Only 1 second to the set temperature

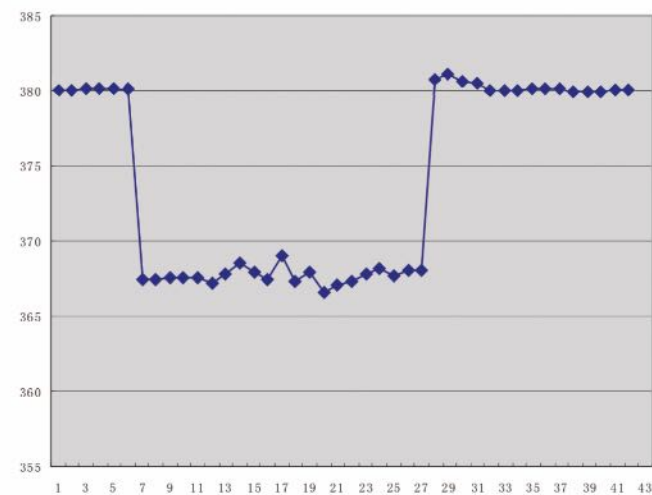

Tester	FLUKE2625A
Soldering tip	TSS02-B
Temperature sensor	K Type (Tested at approximately 1.5 mm from the soldering tip)
Soldering temperature	380°C
Solder wire	Alpha SAC305(96.5%Sn 3%Ag 0.5%Cu)
Soldering amount	ø1.0mm, length 140mm

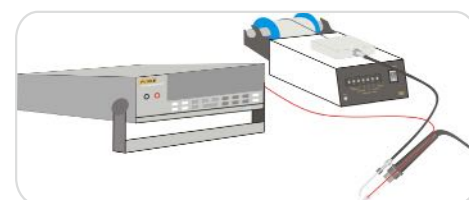

Temperature rise and heat recovery curve comparison

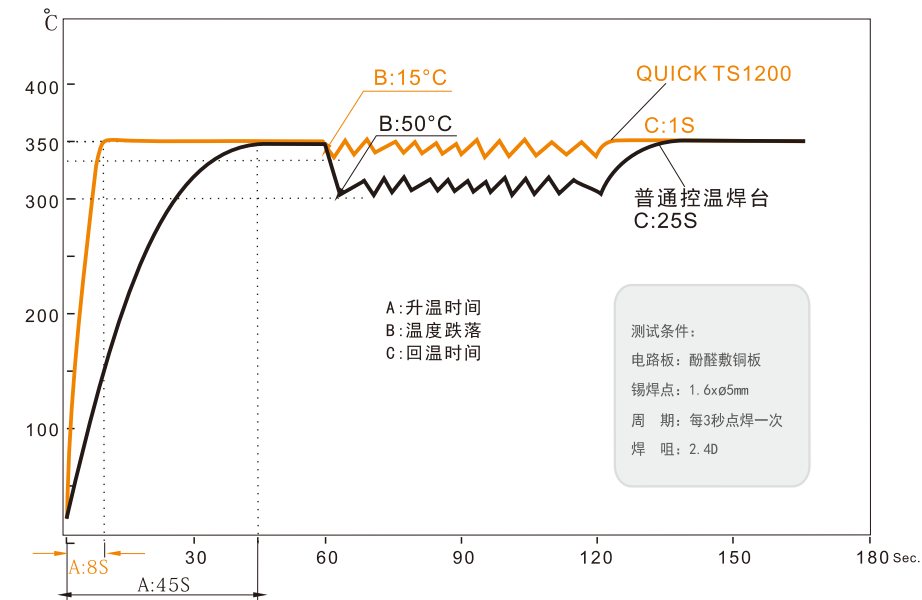

Soldering management software

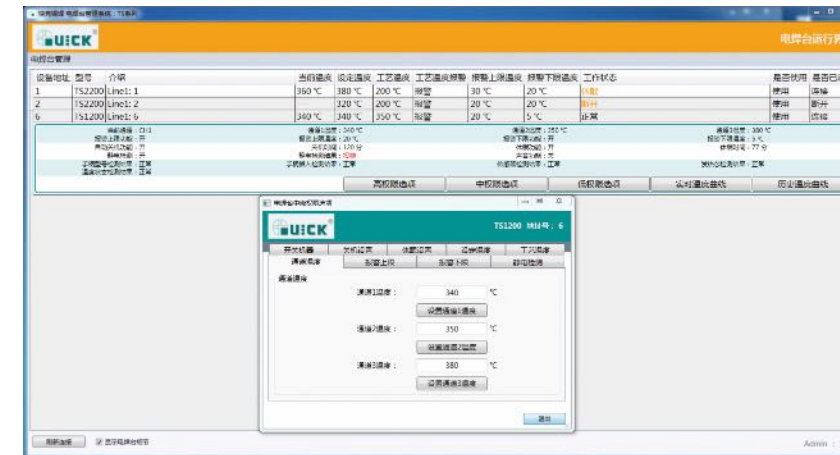

Through the soldering software you can easily realize the setting of the same parameters of multiple soldering stations, achieve unified process management. And the setting of the process parameters of the soldering station is convenient and intuitive.



Through the soldering software you can view the temperature change curve in real time and query the historical temperature data to facilitate the creation of a reasonable soldering process and data control.

SOLDERING STATION

QUICK/TS1100



● Tips See P20



Touch switch



Intelligent recognition handle

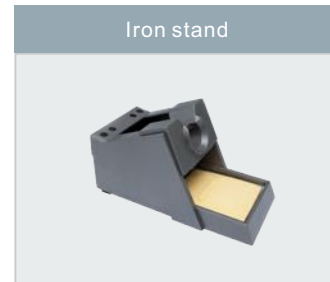

Iron stand

Features

- Digital temperature calibration, temperature locked by password.
- Parameters of three channels pre-set memory.
- Temperature alarm function, °C and °F interchangeable.
- Light soldering iron, incompatible soldering iron recognition.
- LCD screen, plug-in design of heating element for easy maintenance.
- ESD safe design, ESD testing function.

Specifications

Temperature displaying type	LCD
Power consumption	90W
Working voltage	110V/220VAC
Temperature Range	200°C~450°C/392°F~842°F
Ambient Temperature(Max)	40°C
Tip to Ground Resistance	<2mV
Tip to Ground Potential	<2Ω
Dimension (W×H×D)	113×150×92 mm
Weight	About 2.3 kg

SOLDERING STATION

QUICK/TS1200



● Tips See P19



Pluggable soldering tip



Intelligent recognition handle



Touch switch

Features

- Digital temperature calibration, temperature locked by password.
- Parameters of three channels pre-set memory.
- Temperature alarm function, °C and °F interchangeable.
- Sensor close to the tip, detect real-time temperature of tip, ensure rapid thermal recovery.
- Plug-in design of heating element and soldering tip for easy replacement.
- Adjustable turn off function, adjustable sleep function.
- ESD design, ESD testing function.

Specifications

Temperature displaying type	LCD
Power consumption	120W
Working voltage	110V/220V AC
Temperature Range	200°C~420°C/392°F~780°F
Ambient Temperature(Max)	40°C
Tip to Ground Resistance	<2mV
Tip to Ground Potential	<2Ω
Dimension (W×H×D)	137×168×114mm
Weight	About 2.7 kg

SOLDERING STATION

QUICK TS1300



● Tips See P21



Features

- Digital temperature calibration, temperature locked by password.
- Temperature alarm function, °C and °F interchangeable.
- Light soldering iron, incompatible soldering iron recognition.
- LCD screen, plug-in design of heating element for easy maintenance.
- ESD safe design, ESD testing function.

Specifications

Temperature displaying type	LCD
Power consumption	300W
Working voltage	110V/220VAC
Temperature Range	200°C~450°C/392°F~842°F
Ambient Temperature(Max)	40°C
Tip to Ground Resistance	<2mV
Tip to Ground Potential	<2Ω
Dimension (W×H×D)	190×190×134 mm
Weight	About 2.7kg

SOLDERING STATION

QUICK TS2200



● Tips See P22



Features

- Can preset process parameter in three channels, more practical.
- Temperature alarm function, °C and °F interchangeable.
- Real-time monitor temperature of tip, rapid thermal recovery.
- Easy tip replacement.
- ESD safe, ESD monitoring function available.

Specifications

Temperature displaying type	LCD
Power consumption	90W
Working voltage	110V/220VAC
Temperature Range	100°C~480°C/212°F~896°F
Ambient Temperature(Max)	40°C
Tip to Ground Resistance	<2mV
Tip to Ground Potential	<2Ω
Dimension (W×H×D)	137×168×114mm
Weight	About 3.2 Kg

SOLDERING STATION

QUICK/TS2300C



● Tips See P21



Features

- Can preset process parameter in three channels, more practical.
- Temperature alarm function, °C and °F interchangeable.
- Real-time monitor temperature of tip, rapid thermal recovery.
- Easy tip replacement.
- ESD safe, ESD monitoring function available.

Specifications

Temperature displaying type	LCD
Power consumption	150W
Working voltage	110V/220VAC
Temperature Range	100°C~480°C/212°F~896°F
Ambient Temperature(Max)	40°C
Tip to Ground Resistance	<2mV
Tip to Ground Potential	<2Ω
Dimension (W×H×D)	137×168×114mm
Weight	About 2.1 kg

SOLDERING STATION

QUICK/236



● Tips See P20

Features

- Microcomputer digital display, PID temperature control, rapid temperature rising and recovering, suitable for lead free soldering.
- Ceramic heating element, long lifetime.
- Various of tips available, easy operation.
- Digital temperature calibration, easy operation.
- Light handle, user friendly.
- New appearance, firm structure.

Specifications

Power Consumption	90W
Range of temperature	80°C~480°C
Temperature Stability	±2°C Without air flow and no load
Max Ambient Temperature	40°C
Working voltage of heating element	28V AC
Tip to ground potential	<2mV
Tip to ground resistance	<2Ω
Handle Cord Assembly	1.2m
Length of Handle	190mm
Dimension (W×H×D)	60×105×125mm
Weight	About 2.5kg

SOLDERING STATION

QUICK/203H



● Tips See P22

Features

- Sensor close to tip, accurate temperature control, rapid thermal recovery.
- Separate design of soldering tip, sensor and heater, low replacing cost.
- Temperature-lock function, protect soldering process.
- Digital temperature calibration, easy operation.
- Auto sleeping and power off function.

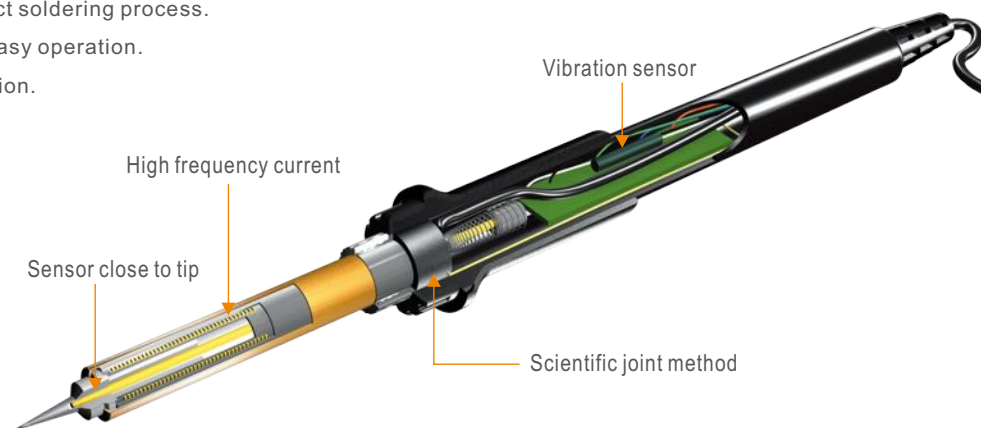

Specifications

Power Consumption	90W
Working voltage	110V/220V AC
Range of temperature	50°C~600°C
Max Ambient Temperature	40°C
Temperature Stability	±2°C (stationary air, no load)
Housing Material	Aluminum
Outer Dimension(W×H×D)	160 × 130 × 100mm
Weight (Cord not included)	About 3.2kg

SOLDERING STATION

QUICK/205



● Tips See P21

Features

- High frequency current heating, rapid heating and thermal recovery.
- Micro computer control, digital calibration, temperature adjustable, auto sleeping and auto shut-off functions available.
- Large power 150W.
- Temperature locked by password, ensure the soldering process.
- Insert-plug design of heating element, easy maintenance, various tips available.

Specifications

Power Consumption	150W
Range of temperature	50°C~600°C
Tip to Ground Resistance	<2Ω
Tip to Ground Potential	<2mV
Max Ambient Temperature	40°C
Temperature Stability	±2°C / Without air flow and no load
Housing Material	Aluminum
Outer Dimension(W×H×D)	200 × 130 × 100 mm
Weight (Without cord)	About 4.6kg

SOLDERING STATION

QUICK/3104



● Tips See P20

Features

- Heat resistant and long lifetime heating element.
- Rapid heating and thermal recovery, precise and stable temperature control.
- Various long lifetime soldering tips available, easy for using.
- Light soldering iron, comfortable for using.
- New appearance, stable structure.

Specifications

Temperature Displaying	LCD
Temperature Range	100°C~450°C(Decide by working mode)
Power	110 V/220V AC
Power Consumption	80W
Ambient Temperature(Max)	40°C
Temperature Stability	±2°C(stationary air, no load)
Tip to Ground Resistance	<2Ω
Tip to Ground Potential	<2mV
Handle Cord	1.2m (Length can be customized as per requirements)
Dimension(W×H×D)	83×125 ×140 mm
Weight(not including handle)	About1.7Kg

SOLDERING STATION

QUICK/3202



● Tips See P22

Features

- High frequency current heating, sensor close to tip.
- Large LCD design displaying the set and real temperatures simultaneously.
- Micro computer control, rapid heating and thermal recovery.
- Digital temperature calibration, insert-plug design of heating element, easy maintenance.
- Temperature locked by password, three favorite temperatures can be set and saved.
- Optional cleaning ways for tips (sponge and metallic sponge).
- Separate design of heating element, sensor and tip, reducing cost of replacing spare parts.
- Suitable for lead free soldering.

Specifications

Power	110V/220V AC
Power Consumption	90W
Temperature Range	100°C~550°C
Temperature Stability	±2°C(stationary air, no load)
Ambient Temperature(Max)	40°C
Tip to Ground Potential	<2mV
Tip to Ground Resistance	<2Ω
Dimension(W×H×D)	96×135×160mm
Weight (not including handle)	About2.0kg

SOLDERING STATION

QUICK/3205



● Tips See P21

Features

- High frequency current heating, rapid heating and thermal recovery.
- Micro computer control, digital calibration, temperature adjustable, auto sleeping and auto shut-off functions available.
- Large power 150W.
- Temperature locked by password, ensure the soldering process.
- Insert-plug design of heating element, easy maintenance, various tips available.

Specifications

Power	110V/220V AC
Power Consumption	150W
Temperature Range	100°C~550°C
Temperature Stability	±2°C (stationary air, no load)
Ambient Temperature(Max)	40°C
Tip to Ground Potential	<2mV
Tip to Ground Resistance	<2Ω
Dimension(W×H×D)	96×135 ×160mm
Weight (not including handle)	About 2.0kg

SELF-FEEDER SOLDERING STATION

QUICK/376D



Features

- High frequency current heating, rapid heating and thermal recovery.
- Micro computer control, digital temperature calibration, auto sleeping function.
- Auto and manual ways of solder feeding optional, auto solder feeding mode can solder nine successive soldering joints at most.
- Imported motor, automatic feeding, coding switch design. More functions available and adjustable, such as feeding speed, feeding volume, interval time, backing time etc.
- Two types of feeding assembly optional, easy to use.
- Pedal switch and manual switch available.

Specifications

Model	QUICK376D	QUICK376D-150	QUICK376DI	QUICK376DI-150
Power	90W	150W	90W	150W
Solder Perforation	No	No	Yes	Yes
Heating principle	High-frequency			
Temperature range	50~600°C			
Temperature stability	±2°C (Still air without load)			
Tip to ground potential	<2mV			
Tip to ground resistance	<2Ω			
Motor	Step motor			
Feeding speed	About 2.7mm/s~27mm/s (36°/s~360°/s)			
Feeding length	0~150mm			
Interval time	0~2.7s			
Backing time	0~0.9s(About 0~25mm Fixed speed: 360°/s)			
Feeding mode	Auto(1~9)/manual(0)			
Solder wire diameter	0.5、0.6、0.8、1.0、1.2、1.4(mm)			
Handle	20H-90	902A	20H-90	902A
Heating element	H1203-90W	H1205	H1203-90W	H1205
Soldering tip	200 series	500 series	200 series	500 series
Weight	About 4.4kg	About 4.2kg	About 4.6kg	About 4.4kg

QUICK/376DI

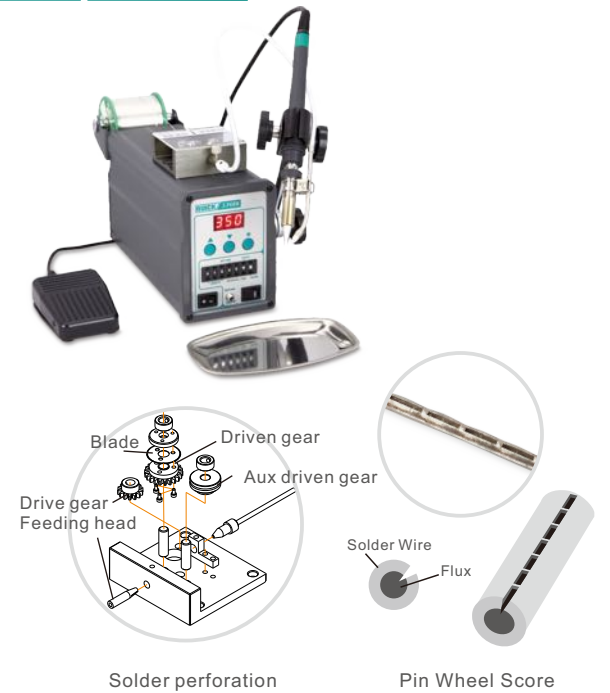

SELECTING A SOLDERING TIP

It is very important to choose the correct soldering tip. A suitable soldering tip can make the work more efficient and increase the durability of the tip. The size of the soldering tip is directly related to the heat capacity. For continuous soldering, the larger the soldering tip is used, the smaller the temperature drop. In addition, because of the higher heat capacity of the large soldering tip and the relatively low temperature during soldering, the soldering tip is less susceptible to oxidation and extends its service life. In general, the selection of soldering tip shall not affect the adjacent components. Selecting the geometry that is in full contact with the soldered joints can improve the soldering efficiency.

Tip type	I type (Pointed)	B type (Conical)	D type (Slot-type)	C type (horseshoe type)	K type (knife-type)
Content					
Features	Soldering tip is pointed	B-type soldering tip has no directionality, and the entire front end of the soldering tip can be soldered.	Soldering with the slotted tip;	Soldering with the beveled portion of the soldering tip, suitable for soldering in need of a large amount of solder.	Use the knife-shaped part to solder, Vertical or drag soldering is allowed belonging to multi-purpose soldering tip
Applications	Suitable for fine soldering, or when the soldering space is narrow, and also capable of correcting the solder bridge produced when the chip is soldered.	Suitable for general soldering. Regardless of the size of the soldered joints, B-type soldering tip can be used	Suitable for soldering with a large amount of solder, such as soldering conditions with a large soldering area, thick terminals and large soldered joints	The application range of the C-type soldering tip is similar to that of the D-type soldering tip. For example, it is used in case of large soldering area, thick terminal, and large soldered joints..	Used for soldering SOJ, PLCC, SOP, QFP, power source, earth element, modified tin bridge, and connector, etc.
Illustrations					

Use and maintenance of the soldering tip

- When the new tip is used for the first time, set 250~280°C to protect the soldering tip with solder.
- Select an appropriate soldering tip based on the soldered joint size.
- To prevent the soldering tip from oxidation, a layer of fresh solder should be applied before returning to the soldering iron stand.
- The cleaning sponge should not have too much water, so that the soldering tip can be cleaned well, and can be prevented from being cooled rapidly. If dry cleaning sponge is used, the soldering tip will be damaged and the solder can not be applied.
- After the soldering tip is oxidized due to improper use, do not polish the surface coating by sanding. Use metal filaments or a reactivation paste to clean the soldering tip at low temperature (250-280 °C).
- Do not apply gravity to the soldering tip during soldering and avoid using tin on the same position.
- Try to solder at low temperature. Generally, the soldering temperature is controlled at 320~380 °C. If you need to set high temperature to solder, please analyze whether the soldering station and soldering tip are matched.

Steps for removing the oxidation on the soldering tip



Per the diameter of Soldering Pad

D ≤ 1mm
Soldering Station Power : 60-120W
Soldering Method: Point Soldering
Recommended Model: B / J / 0.8D / 1.2D / 0.8C / 1C / SK / K

D = 1-2mm
Soldering Station Power : 60-120W
Soldering Method: Point Soldering
Recommended Model: B / J / 1.2D / 1.6D / 2C / SK / K

D = 2-5mm
Soldering Station Power : 90-150W
Soldering Method: Point Soldering
Recommended Model: 2.4D / 3.2D / 4.2D / 3C / 4C / 5C / K

D = 5-8mm
Soldering Station Power : 150-300W
Soldering Method: Point Soldering
Recommended Model: D / 6D / 8D / 5C / 6C / 8C

D ≥ 8mm
Soldering Station Power : 150-300W
Soldering Method: Point Soldering
Recommended Model: D / 10D / 15D / 8C / 10C / 15C

根据器件类型

DIP
Soldering Station Power : 90-120W
Soldering Method: Point Soldering / Drag Soldering
Recommended Model: (Point Soldering) B / 1.2D / 1.6D / 2.4D / 2C (Drag Soldering) K / SK / 3C / 4C /

QFP
Soldering Station Power : 90-120W
Soldering Method: Point Soldering / Drag Soldering
Recommended Model: (Point Soldering) B / 0.8D / 1.2D / J / 0.8C / (Drag Soldering) K / SK / 2C / 3C / 4C

SOP
Soldering Station Power : 90-120W
Soldering Method: Point Soldering / Drag Soldering
Recommended Model: (Point Soldering) B / 0.8D / 1.2D / J / 0.8C (Drag Soldering) K / SK / 2C / 3C / 4C

MOS管
Soldering Station Power : 90-120W
Soldering Method: Point Soldering
Recommended Model: (Point Soldering) K / 3.2D / 4.2D / 4C / 5C

Specifications: **0603** Recommended Model: B / 0.8D / 1.2D / J / 0.8C / 1C
Specifications: **0402** Recommended Model: B / 1 / 0.8D / 0.8C / J
Specifications: **0201** Recommended Model: 1 / J

Soldering Station Power : 60-120W
Soldering Method: Point Soldering

Cautions:
Soldering tips are not subject to high temperature and great force. High temperature will make the flux volatilize and will decline the quality of the solder joint. The size of soldering tips shall be close to that of soldering pad so that the soldering tip can fully contact the pad. Soldering tips should be large rather than small, and short rather than long if possible.

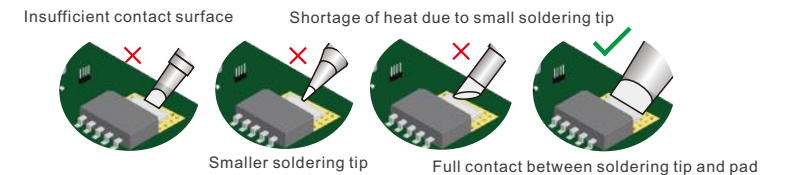

▲ QUICK TS1200 Replaceable Tips

Conical Type	TSS02-I	TSS02-I-02	TSS02-B	TSS02-2B	TSS02-J-01
C Type	TSS02-0.8C	TSS02-1C	TSS02-2C	TSS02-3C	TSS02-4C
D Type	TSS02-0.8D	TSS02-1.2D	TSS02-1.6D	TSS02-2.4D	TSS02-3.2D
	TSS02-4.2D	TSS02-6.5D	TSS02-10D-01	TSS02-20D-01	TSS02-1.6H-01
K Type	TSS02-SK	TSS02-K	TSS02-4.2DK-01		

▲ Sectional View

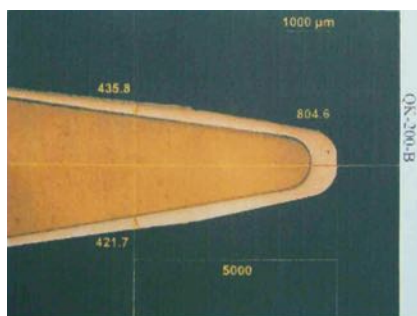

- Copper- heat conductor, main component
- Iron – anti-corrosion, key to tip lifetime.
- Chromium - tin free material, prevent tin climbing.
- Tin - prevent tip oxidation.

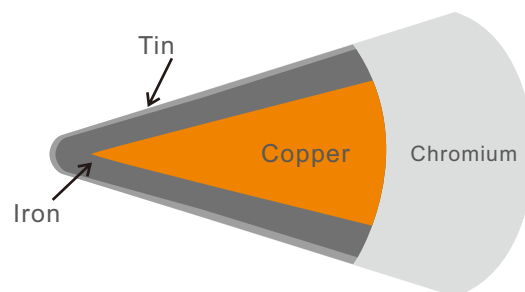

▲ QUICK TS1100 236 969 967 375A+375B+3104 Series Replaceable Tips

Conical Type	960-I	960-B	960-LB	960-2B	960-J
C Type	960-0.8C	960-1C	960-2C	960-3C	960-4C
D Type	960-0.8D	960-1.2D	960-1.6D	960-2.4D	960-3.2D
K Type	960-SK	960-K			

▲ QUICK303D Replaceable Tips

Conical Type	305-I	305-B	305-LB	305-2B	
C Type	305-1C	305-2C	305-3C	305-4C	305-5C
D Type	305-0.8D	305-1.2D	305-1.6D	305-2.4D	305-3.2D
K Type	305-SK	305-K	305-LK		

▲ QUICK1300 Series Replaceable Tips

C Type	503-4C-01	503-6C	503-10C	
D Type	503-6D	503-10D-01	503-15D	503-15D-01
	503-6DU-01	503-10DU-01	503-6DV2-01	
K Type	503-K-01	503-K-02		

▲ QUICK TS2300 205 3205 376D-150 Replaceable Tips

Conical Type	500-B	500-B-01	500-2B		
C Type	500-3C	500-4C	500-5C	500-6C	500-8C
D Type	500-3.5D	500-5D	500-8D		
K Type	500-SK	500-K	500-4DK		

▲ QUICK TS2200 203H 503 504 203D 376D Replaceable Tips

Conical Type	200-I	200-B	200-LB	200-2B	200-J
C Type	200-0.8C	200-1C	200-2C	200-3C	200-4C
D Type	200-0.8D	200-1.2D	200-1.6D	200-2.4D	200-3.2D
K Type	200-SK	200-K	200-LK		

▲ QUICK3202 713 Replaceable Tips

Conical Type	200G-I	200G-B	200G-LB	200G-2B	200G-J
C Type	200G-0.8C	200G-1C	200G-2C	200G-3C	200G-4C
D Type	200G-0.8D	200G-1.2D	200G-1.6D	200G-2.4D	200G-3.2D
K Type	200G-SK	200G-K			

SOLDER POT

QUICK/100-4C



QUICK/100-6CA



Features

- Closed-loop sensor controls temperature, zero triggering without polluting the operating voltage.
- Adopts anti-erosion and heat resistant alloy materials, long lifetime, suitable for lead free applications.
- Small capacity design, more suitable for small and medium-sized connectors.

Specifications

Model	QUICK100-4C	QUICK100-6CA
Power	200W	400W
Solder pot size	∅ 36×32(H)mm	∅ 54×38 (H) mm
Solder amount usable	About 0.3kg	About 0.7kg
Temperature range	150℃~500℃	150℃~450℃
Temperature stability	±5℃ (Still air without load)	±5℃ (Still air without load)
Outer dimensions	91×150×75 (mm)	190×115×75(mm)
Weight	About 0.9kg	About 1.3kg

SOLDER POT

QUICK/100-15S



Features

- Closed-loop sensor controls temperature, zero triggering without polluting the operating voltage.
- Using anti-erosion and heat resistant alloy materials, long lifetime, suitable for lead free applications.
- Rapid temperature rising, accurate and stable temperature.
- LCD displays the temperature.
- Digital temperature calibration, easy and convenient to use.

Specifications

Model	QUICK100-15S
Power	600W
Solder pot size	98*130*58(mm)
Solder amount usable	About 6kg
Temperature range	100℃~450℃
Temperature stability	±5℃ (Still air without load)
Outer dimensions	200×320×100(mm)
Weight	About 4.2kg

Schematic diagram of operation

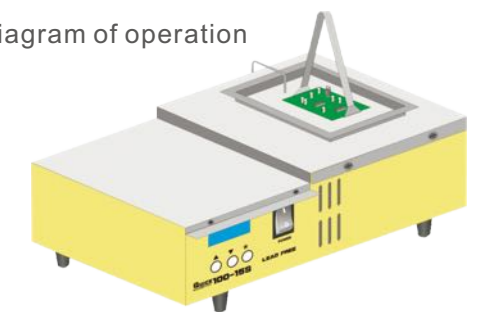

Soldering small PCB

THERMOMETER

QUICK 191AD Thermometer



Diagram of accessories

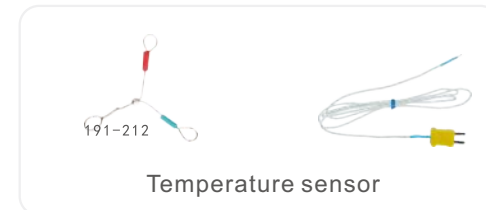

Temperature sensor



Temperature calibration

Features

- Measure tip temperature quickly and accurately with CA sensor (Dia 0.2mm).
- Auto shut-off function available , shut-off time can be set. If the time when the unit is not in use reaches the set value, the unit shuts it off automatically.
- Can record max temperature. It shows the highest temperature of tip when pressing (MAX HOLD) button.
- Celsius and Fahrenheit interchangeable.

Specifications

Model	QUICK 191AD	
Temperature range	(0~800)°C	(32~1500)°F
Resolution	Celsius(1°C)	Fahrenheit(1°F)
Precision	±5°C	±10°F
Auto shutdown time range	1~240min	
Sensor type	K type thermocouple	
Display	LCD Display	
	a)Battery low voltage warning display B	
	b)Sensor damage display1	
Power source	9V battery	
Outer Dimensions	85x35x147(mm)	
Weight	About 200g(including battery)	
Ambient temperature	0~40°C	

SOLDERING TESTER

QUICK 192 Soldering Tester

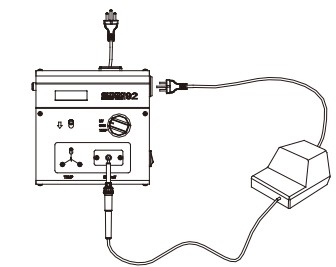

Schematic diagram of test

Features

- Measure tip temperature, leak voltage and ground resistance accurately.
- 2-in-1 design, can be used to measure the temperature of solder pot and other solvent with a probe.
- Use reliable micro-computer check, high precision.
- Meet MIL-STD-2000 leak voltage measurement standard.

Specifications

Temperature	Resolution	1°C
	Measuring range	0~600°C (32°F ~1200°F)
	Precision	±3°C/±6°F
Voltage	Sensor	K-type thermocouple
	Resolution	0.1mv
	Measuring range	0~90mv(AC)
Resistance	Precision	±(3%+2 characters)
	Meets MIL-STD-2000 standard	
	Resolution	0.1Ω
Display	Measuring range	0~90Ω
	Precision	±(1%+2 characters)
	LCD	3½ LCD digital display
Power	Exceed the limit	□□□□
	Power	2W
	Outer dimensions	158x150x50(mm)
Weight	About 1kg	
Ambient temperature	0~40°C Relative humidity 0~80%	

HOT AIR THERMOMETER



QUICK/196



Features

- Specialized hot air station temperature tester, the sensor can measure the temperature of air outlet quickly.
- Auto shut-off function available, Shut-off time can be set.
- 【MAX HOLD】 records the highest temperature.
- Centigrade and Fahrenheit interchangeable.

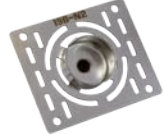
Applicable Models

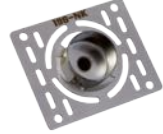
Product				
Test model	850/990 series	856AD/861DA	860/TR1100	861DW/856AE
Test port	196-N1	196-N2	196-N3-A	196-NK

Specifications

Model	QUICK196	
	Celsius(°C)	Fahrenheit(°F)
Resolution	1°C	1°F
Temperature range	(0~800)°C	(32~1500)°F
Precision	±5°C	±10°F
Auto shutdown time range	001~240min	
Sensor type	K-type thermocouple	
	LCD	
Display	a)Battery low voltage warning display B b)Sensor damage display1	
Power source	9V	
Outer dimensions	180x79x138(mm)	
Weight	About 1.0kg(including battery)	
Ambient temperature	0~40°C	

TIP CLEANER

QUICK/310 Tip Cleaner



Features

- Can remove the oxides effectively without damaging the tip.
- When using the chemical paste, the oxides can be easily moved. The tip becomes brighter and then tin it again.
- Compact size and easy operation.

Specifications

Model	QUICK310
Power	5W
Outer dimensions	125*70*65(mm)
Weight	About 0.8kg

FUME EXTRACTOR

QUICK/6101A2



QUICK/6102A2



Features

- Integrative structure design, easy installation, agile movement, no need to lay any pipelines.
- Large-power brushless DC fan generates large air flow.
- Low noise.
- Triple filter design, remove hazardous substances from fume to ensure body safety. Pre- filter and main filter can be replaced separately to make full use of filters and cut down cost.
- Built-in air cycling filtering system, avoid discharging the cool/hot air outside.
- Both air flow and arms adjustable.

Specifications

Model	QUICK6101A2	QUICK6102A2
Work positions	1	2
Static pressure	2400Pa	2800Pa
System flow (including filtrating equipment)	100m ³ /h	2x100m ³ /h
Filtration efficiency(0.3 micron)	99.97%	99.97%
Power	120W	250W
Noise	< 60dB	< 65dB
Voltage	AC 220V	AC 220V
Outer dimensions	420x230x430(mm)	470x230x500(mm)
Weight	About 13.4kg	About 14.2kg

FUME EXTRACTOR

Three alarm functions

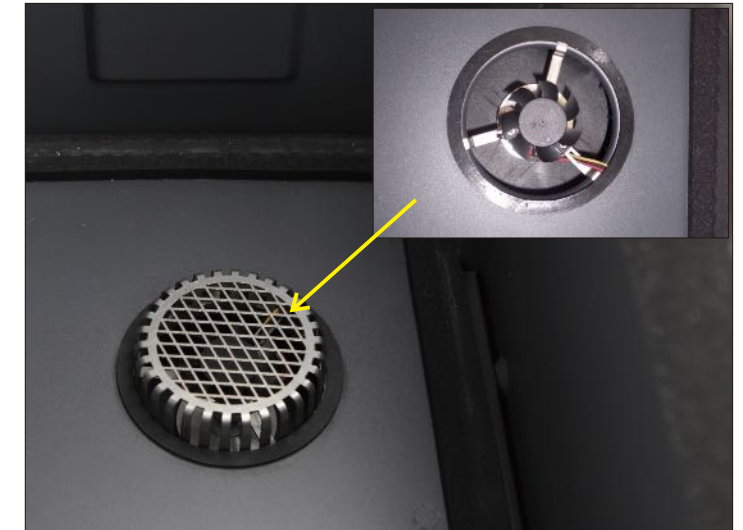
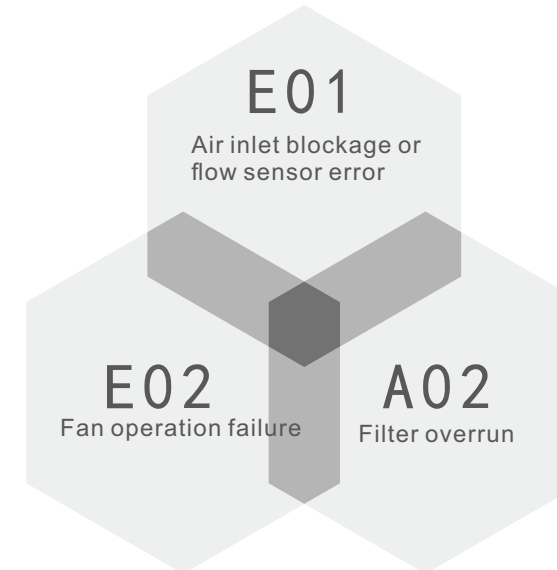

A new flow sensor is added to control the motor speed in real time to ensure a constant flow and stable filtration. When the host machine detects an abnormality, the hand-held control box displays the abnormal code information and prompts the corresponding operation.

Hand-held control box



The hand-held control box can set and control various parameters of the host machine (switching on or off, password protection, flow regulation) and filter element usage. Various running states can be read on the Chinese display device.

Interconnection function

















Interconnected

With its own interconnection interface, it controls the operation and sleep of the purification system through other intelligent peripherals (such as soldering robot/smart soldering station), which is more environmentally friendly and energy-saving.

FUME EXTRACTORS

Model	Photos	Description
KFPS-6100		Primary filter sheet Filter out large-volume particle
KFMS-6100		Middle filter to filter out smaller particles
KFPL-6100		RD primary filter used for laser marking and other occasions, filtering out large particles
KFA1-02-101/102		Main filter used for laser marking and other applications, and for gas filtration
KFH-01-101/102		Main filter used for laser marking and other applications, and for gas filtration
KFS1-07-101B		Filtration of all gases, with a wood frame, used for 6101B
Dust bag		Filter out larger particles, and need support without medium effect filter
KHRR125-75		1. Round fume inlet 2. Anti-electrostatic 3. Anti-scalding 4. Fume inlet diameter is 125mm 5. To connect the fume absorption arm with a diameter of 75mm
KHRR105-50		1. Round fume inlet 2. Anti-electrostatic 3. Anti-scalding 4. Fume inlet diameter is 105mm 5. To connect the fume absorption arm with a diameter of 50mm
KHM1		1. Four-cornered fume collecting hood 2. Anti-scalding (stainless steel) 3. Customized size, suspension type
KHY1		1. Four-cornered fume collecting hood 2. Transparent (acrylic) 3. Customized size, suspension type
KHY2		1. Four-cornered fume collecting hood 2. Transparent (acrylic) 3. Customized size, and placed on the workbench
KAP75-150-75		1. Directly connected to the host machine. The fume inlet can be equipped with KHRR125-75 2. Directional duct, length 150cm, duct and connection diameters are 75mm
KAP50-120-75		1. Interface diameter is 75mm 2. Directional duct, length 120cm, duct diameter 50mm 3. Directly connected to the host machine. The fume inlet can be equipped with KHRR105-50
KAP50-80-50		1. Used with bench clamp; 2. Interface diameter is 50mm 3. Directional duct, length 80cm, duct diameter 50mm

FUME EXTRACTORS

Model	Photos	Description
KAV50-80-50		1. Used with bench clamp; 2. Interface diameter is 50mm 3. Wound-type directional duct, length 80cm, duct diameter 50mm
KAA4-50		1. With a retractable cone-shaped opening; 2. Four-section fume absorption arm with three joints 3. Used with bench clamp, with interface diameter of 50mm 4. The first section is 250mm long, the second section is 430mm long, the third section is 450mm long, and the fourth section is 550mm long.
KAA3-50		1. A fume inlet can be a round port. 2. Three-section fume absorption arm with two joints 3. Used with bench clamp, with interface diameter of 50mm 4. The first section is 250mm long, the second section is 450mm long, and the third section is 380mm long.
KTP50/75		1. Adjustable air port; 2. Interface diameter is 50mm/75mm 3. Directly used on the segmental duct for easy adjustment
KCF-FM50-75		1. With air door 2. The lower part is directly connected with host machine 3. The upper part connects with the fume absorption arm with a connection diameter of 50mm
KCD-FM50-75		1. With air door 2. The lower part is equipped with a flexible connecting tube with a connection diameter of 75mm. 3. It is installed after workbench surface punching, and the upper part connects with the fume absorption arm with a connection diameter of 50mm
KCC-FM50-75		1. With air door 2. The lower part is equipped with a flexible connecting tube with a connection diameter of 75mm. 3. The bench clamp of fume absorption arm; Its upper part connects with the fume absorption arm with a connection diameter of 50mm
KCC75-75		1. The lower part is equipped with a flexible connecting tube with a connection diameter of 75mm. 2. The bench clamp of fume absorption arm; Its upper part connects with the directional duct with a connection diameter of 75mm
KCC50-75		1. The lower part is equipped with a flexible connecting tube with a connection diameter of 75mm. 2. The bench clamp of fume absorption arm; Its upper part connects with the fume absorption arm with a connection diameter of 50mm
KCC50-50		1. The lower part is equipped with a flexible connecting tube with a connection diameter of 50mm. 2. The bench clamp of fume absorption arm; Its upper part connects with the fume absorption arm with a connection diameter of 50mm
KCD75-75		1. The lower part of the bench surface is equipped with a flexible connecting tube with a connection diameter of 75mm. 2. It is installed after workbench surface punching, and the upper part connects with the fume absorption arm with a connection diameter of 75mm
KCD50-50		1. The lower part is equipped with a flexible connecting tube with a connection diameter of 50mm. 2. It is installed after workbench surface punching, and the upper part connects with the fume absorption arm with a connection diameter of 50mm
KCD50-75		1. The lower part of the bench surface is equipped with a flexible connecting tube with a connection diameter of 75mm. 2. It is installed after workbench surface punching, and the upper part connects with the fume absorption arm with a connection diameter of 50mm
KCN75-75		1. the length after straightening is 1m2. One end is connected to the host machine 3. The other end can be connected to the bench clamp, which can directly connect the fume collecting hood with a diameter of 75mm.
KCN50-75		1. the length after straightening is 1m2. One end is connected to the host machine 3. The other end can be connected to the bench clamp, which can directly connect the fume collecting hood with a diameter of 50mm.

REWORK STATION

The intelligent rework station is a type of efficient and practical multi-functional product developed according to the development of electronic technology and demands of personnel engaged in electronic products research, production and repair. Based on the principle of hot air heating solder melting, it quickly and cleanly removes the components in various encapsulation methods, and protects the components and PCB against damage.

As the electronic technology is upgraded continuously, the components and parts become more precise, miniaturized, and PCB has multiple layers and high integration level, higher requirements are set forth for the reworking tools. The safe and efficient rework equipment is generated under this circumstance. With "multi-point section programmable" technology, the new type of equipment reduces the thermal shock to the components and draws different temperature curves for different components; with advanced "planet connection structure", it effectively reduces the air outlet resistance and extends the lifetime of heating element. The automatic cooling and sleeping technologies protect the heating element while saving the energy. The quick plug type fixed structure facilitates the adjustment of nozzle direction to keep consistent with the direction of reworking components pins, so that the reworking components can be heated evenly to melt the solder at the components pins, improve the reworking efficiency.

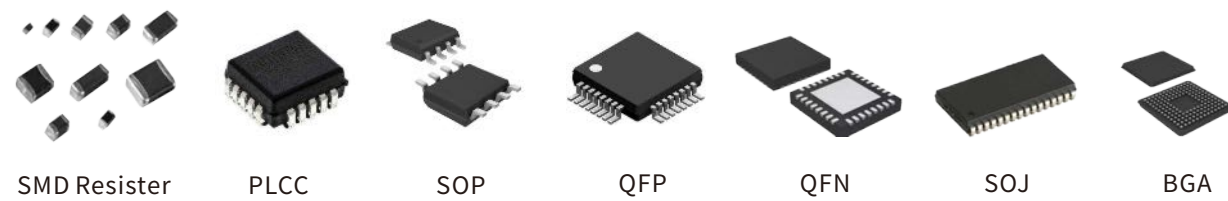

SMD Resistor PLCC SOP QFP QFN SOJ BGA

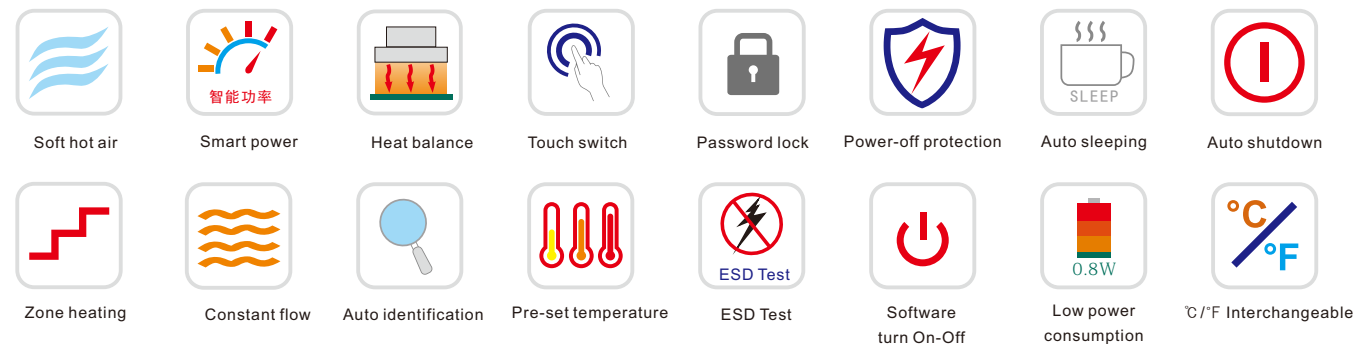

REWORK STATION

QUICK TR1300



● Nozzles See P43

QUICK NOZZLE REPLACEMENT



Features

- Multi-point temperature digital calibration, temperature locked by password.
- Parameters of three channels pre-set memory.
- Temperature alarm function, °C and °F interchangeable.
- Twin-stage brushless blower pump for stable airflow, long life.
- Temperature, airflow, working time and other parameters can be set.
- Plug-in design of ceramic heating element for stable temperature, long life and easy maintenance.
- ESD design, ESD testing function.
- Can be controlled via PC.

Specifications

Model	TR1300
Display	TFT
Power Consumption	1300W
Working Voltage	110V / 220VAC
Temperature Range	100°C~500°C/212°F~932°F
Airflow	6~70L/MIN
Dimension (W×D×H)	215×230×155 (mm)

REWORK STATION

QUICK TR1100

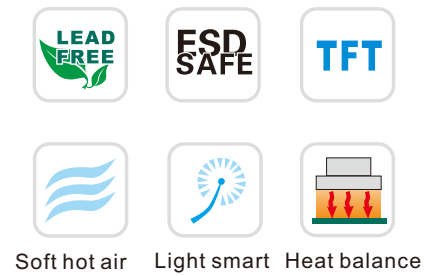

Features

- Multi-point temperature digital calibration, temperature locked by password.
- Parameters of three channels pre-set memory.
- Temperature alarm function, °C and °F interchangeable.
- Twin-stage brushless blower pump for stable airflow, long life.
- Silent design of the rework station, with noise lower than 55dB.
- Plug-in design of ceramic heating element for stable temperature, long life and easy maintenance.
- Light handle, comfortable for using, suitable for long-time work.
- ESD design, ESD testing function.

Specifications

Power Consumption	200W
Working Voltage	110V/220V AC
Temperature Range	100°C-500°C/ 212°F- 932 °F
Temperature Stability	± 2°C (Stationary air, no load)
Airflow	1.5- 7.0L/ Min
Dimension (W×D×H)	190 x 190 x 134 (mm)
Weight	About 3.5 Kg



It generates soft and balance hot air. With light handle, it is comfortable to hold. Precision reworking effectively guarantee the nearby component is not subjected to the thermal shock. It is particularly suitable for mini CHIP components.

Technological parameter



Split design



Software turn On-Off



Pre-set temperature



REWORK STATION

QUICK TR1300A



● Nozzles See P43

Features

- Multipoint temperature digital calibration, password lock function.
- Parameters of three channels pre-set memory.
- Temperature alarm function, °C and °F interchangeable.
- Adopt two-stage supercharging brushless pump, air pressure stability, long life.
- Set the parameters such as temperature, air velocity and time.
- Ceramic heating element, plug type design.
- ESD design, ESD testing function.

Specifications

Model	TR1300A
Display	TFT
Power Consumption	1300W
Working Voltage	110V / 220VAC
Temperature Range	100°C~500°C/212°F~932°F
Airflow	6~70L/min
Dimension (W×D×H)	215×230×155 (mm)

REWORK STATION

QUICK/861DW Lead-free Hot Air Rework Station



● Nozzles See P43

Features

- Three regular channels "CH1", "CH2" and "CH3", each channel's parameters including temperature and airflow can be set.
- Password protection and key-lock functions.
- Real time operation by the magnetic switch, enter sleeping state when the handle is placed on holder.
- Auto sleeping function, parameters can be set in sleeping mode.
- Closed-loop sensor, temperature can be controlled by zero voltage triggering mode and adjusted conveniently, accurate and stable, not affected by airflow, large power, rapid heating.
- A multipurpose unit, with brushless whirlpool motor, wide range and stepless adjustable airflow.
- An automatic cooling system can prolong the lifetime of heating element and protect the handle.

Specifications

Power	1000W
Operating voltage	AC 220V
Temperature range	100- 500 °C
Air volume range	1- 120 Class
Overall dimensions	188 x245 x 135 (mm)
Weight	About 3.9kg

REWORK STATION

QUICK/856AE Lead-free Hot Air Rework Station



● Nozzles See P43

Features

- Three channels CH1, CH2 and CH3, parameters of each channel like time, air volume and temperature can be preset, can be changed in channel CH0.
- Password protection and button lock function available, prevent menu from being changed at will.
- Easy real-time operation, auto sleeping function available, parameters can be set in sleeping mode.
- Closed loop sensor, temperature controlled by micro computer zero trigger, large power, rapid temperature rising, temperature can be easily and accurately adjusted, not affected by airflow.
- Brushless vortex fan, wide range of airflow adjustable, suitable for many applications.
- Auto cooling function available, long lifetime ceramic heater.

Specifications

Power	1300W
Operating voltage	AC 220V
Temperature range	100- 500 °C
Working time	1- 999 s ("---" refers to no time limiting)
Air volume range	6- 200 Class
Vacuum pressure	600 mmHG (only for QUICK 856AX)
Overall dimensions	250 x 230 x 150 (mm)
Weight	About 5.0kg

REWORK STATION

QUICK/957DW+



● Nozzles See P44

Features

- Closed loop sensor, large power and rapid heating.
- Stepless airflow adjusting with a wide range.
- Sensitive electromagnetic inductor in handle, easy to use.
- Automatic cooling system available,
- Compact unit

Specifications

Display type	LED number(resolving capability is 1°C)
Power consumption	580W
Airflow type	Soft revolving airflow
Temperature Range	100°C~450°C
Airflow Capacity	50L/min

DESOLDERING TOOL

QUICK/201B

Anti-static Desoldering Tool



Features

- Powerful built-in vacuum pump.
- Precise temperature controlled by closed-loop sensor.
- 36V low voltage heater, fully isolated, safe and reliable.
- Digital temperature calibration.
- Specially designed suction nozzle, even melting solder can be absorbed into filter, no need of frequent maintenance, high efficiency.

Specifications

Pump power	12V/ 2A
Heating power	120W
Temperature range	200- 450 °C
Pump	Diaphragm type
Vacuum pressure	600 mmHg
Tip to ground resistance	< 2 Ω
Tip to ground potential	< 2 mv
Overall dimensions	105 x 250 x 165 (mm)
Weight	About 4.8kg

Replaceable nozzles

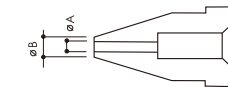

P/N	øA(mm)	øB(mm)
A1004	0.8	2.3
A1005	1.0	2.5
A1006	1.3	3.0
A1007	2.0	3.0

Operation diagram



2-IN-1 REWORK STATION

QUICK/713

QUICK/712



Features

- Password lock function, with auto sleeping/shutoff function.
- Digital temperature calibration, easy operation.
- Suction pen inside hot air handle, convenient for using.
- Brushless fan, adjustable, stepless and wide range of air volume, suitable for various occasions.
- Built-in vacuum pump, powerful suction, no need of external vacuum system.

Specifications

Soldering section	QUICK713	QUICK712
Power	90W	90W
Temperature range	200- 480℃	50- 500℃
Sleeping temperature range	200 ℃	50 ℃ -200 ℃
Sleeping time range	0- 99 min	0- 250 min
Temperature stability	±2 ℃ (Stationary air, no load)	±2 ℃ (Stationary air, no load)
Ambient temperature(Max)	40 ℃	40 ℃
Tip to ground resistance	< 2Ω	< 2Ω
Weight	About 7.9kg	About 4.8 Kg

(Only for QUICK713)

Rework section	Specifications	Desoldering section	Specifications
Power	1000W	Heating power	90W
Temperature range	100- 500 ℃	Temperature range	200 – 480 ℃
Air volume	1-120 Class	Pump	Diaphragm type
Ambient temperature(Max)	40 ℃	Vacuum pressure	600 mmHg
Temperature stability	± 2 ℃	Sleep time range	1-100 min

PREHEATER

QUICK/854 Infrared Preheater



Specifications

Power	400W
Heating area	130 * 130 (mm)
Heater material	Ceramic
Temperature sensor	K- type thermocouple
Temperature range	50 -350℃
Range of thermometer	0- 600 ℃
Ambient temperature	0- 40 ℃
Temperature stability	± 1 ℃
Overall dimensions	255* 200* 63 (mm)
Weight	About 2.1kg

Features

- Imported infrared ceramic heater, fast heating, high efficiency, long life time.
- Built-in thermometer, can check temperature of PCB conveniently.
- Closed-loop sensor, PID control, temperature accurate and stable.
- Suitable for PCB preheating and other process which requires whole and even heating.

QUICK/870 Pre-heater/ Reflow Hot Plate



Specifications

Power	800W
Heating area	180 x 200 (mm)
Plate material	Aluminum
Temperature sensor	K type thermocouple
Temperature range	50- 300 ℃
Ambient temperature	0- 40 ℃
Temperature stability	± 2 ℃
Overall dimensions	280 * 290 * 100 (mm)
Weight	About 6.3kg

Features

- Special heater, surface temperature distributes evenly.
- Closed-loop sensor, PID control, precise and stable temperature.
- Two switches control power supply and heating separately. Actual temperature of the plate displays even under unheated conditions, can avoid accidents.
- Suitable for PCB preheating and other process which requires whole and even heating.



Nozzles for QUICK861DW/856AX/856AE/855PX/712/713

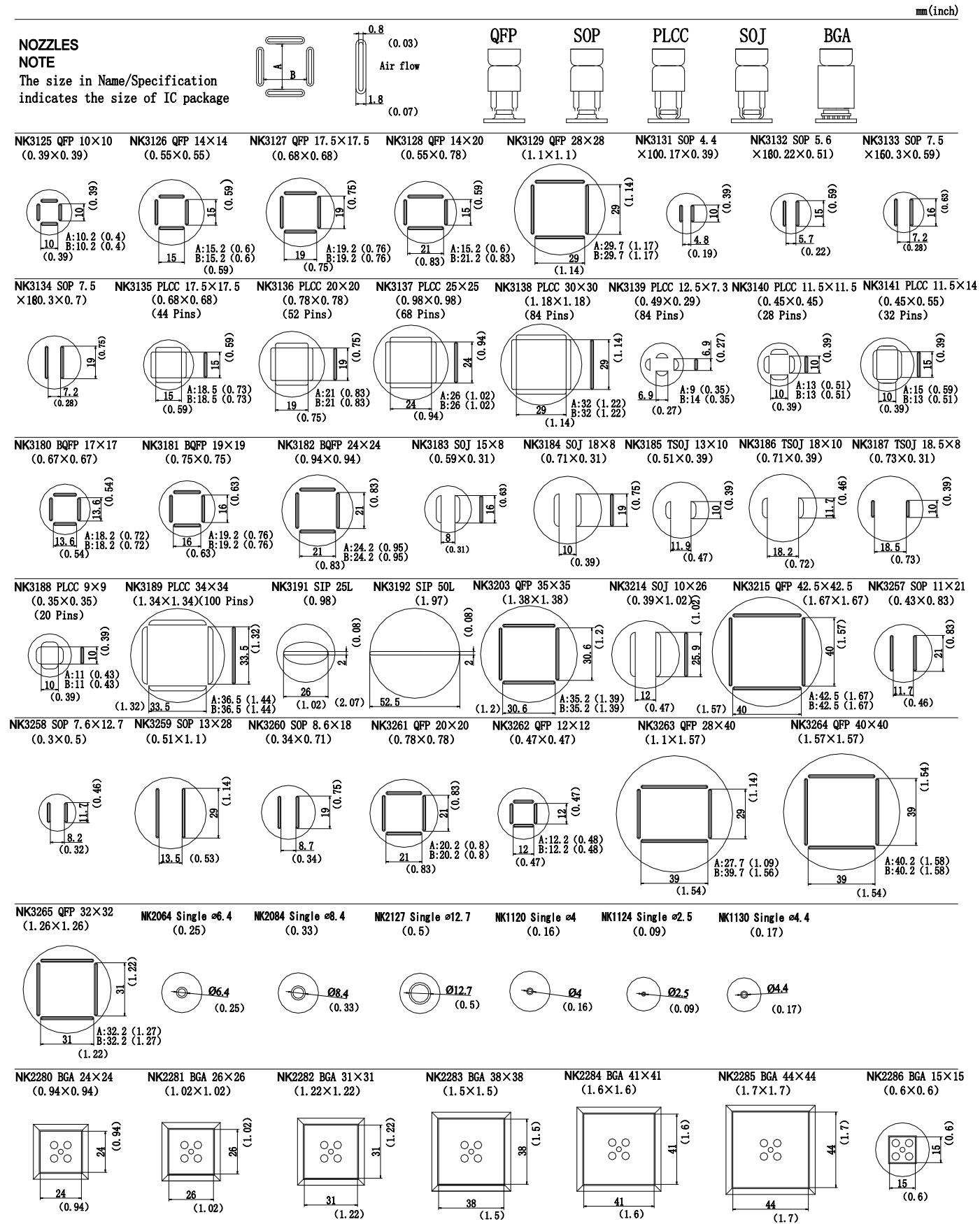

Nozzles for QUICK855PG

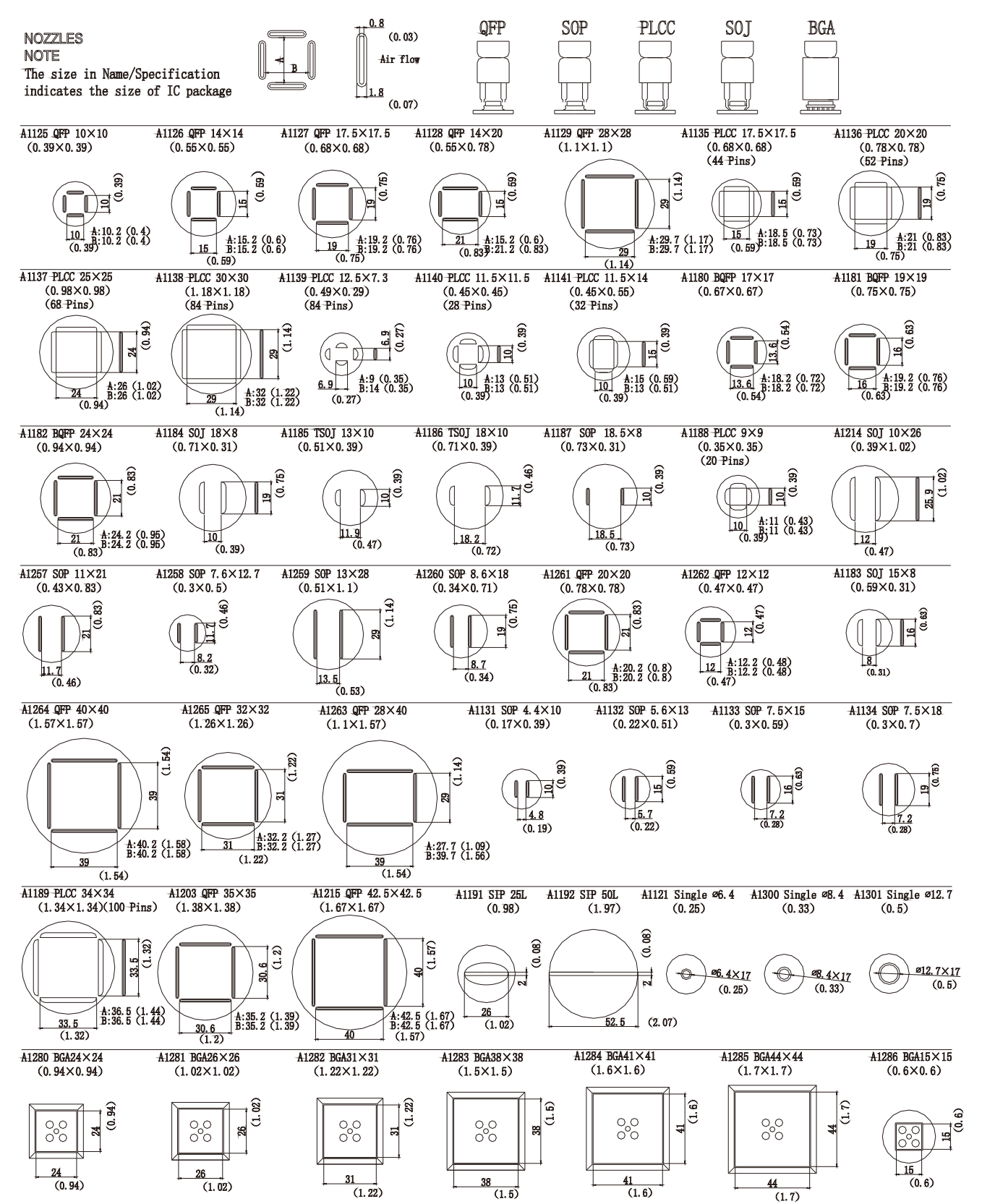

* Nozzles for different ICs like QFP, PLCC, and BGA etc can be customized.

STATIC ELIMINATOR

QUICK/443C Static Eliminator



QUICK/443D Static Eliminator



Features

- LED screen displaying ion balance, excellent ion balance and stability.
- Alarm range of ion balance can be set, sound and light alarm.
- Wide range of air volume, adjustable steplessly.
- Can be connected to PC by RS485 connector, easy control.
- Easy cleaning and replacing of emitter pin.
- Compact size, light, portable design, adjustable angle of fan.

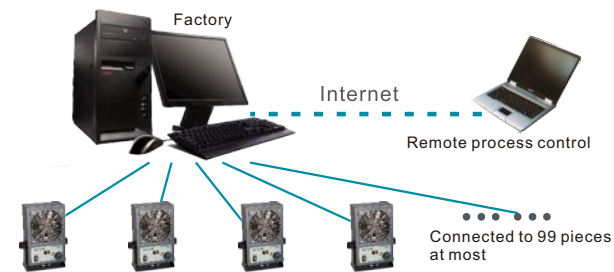

Specifications

Model	QUICK 443 series
Power (Max)	27W
Output voltage	± 5000 VDC
Range of ion balance alarm value	± 15V- ± 50V
Ozone generating amount	Lower than 0.01 PPM (measured at 15 cm in front of the fan)
Effective range of ion air zone	400* 1500 (mm)
Overall dimensions	190 x 95 x 240 (mm)
Weight	About 2.5kg

STATIC ELIMINATOR

QUICK/440A AC Static Eliminator



Practical picture

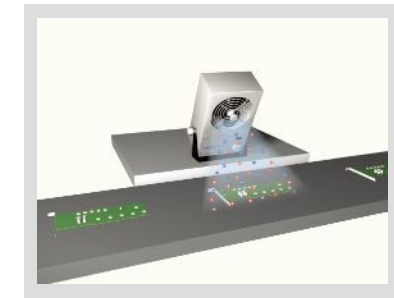

PCB assembly

Features

- Compact size, light, portable design, adjustable angle.
- Quickly neutralizes static charges.
- Large area of ionizing air.
- Speed of fan adjustable, can generate large-area ion stream.
- Stable and adjustable ion balance.
- Long lifetime magnetic leakage transformer, can protect the unit from short circuit.
- Built-in emitter cleaner, easy cleaning.

Specifications

Power	12W
Output voltage	AC 5.6 KV
Ion balance	≤ ± 10V
Air volume	≤ 2.4 m3 /min
Effective range	400 * 1500 (mm)
Ozone generating amount	Lower than 0.03 PPM (measured at 15 cm in front of the fan)
Fan noise	45 dB
Ambient temperature	0 ℃ - 40 ℃
Overall dimensions	140 x 84 x220 (mm)
Weight	About 2.9kg

STATIC ELIMINATOR

QUICK/441B Static Eliminator

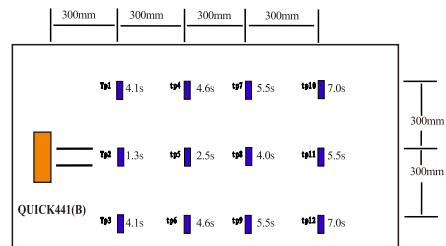

Note: Test conditions: Large air volume ($\approx 3.3 \text{ m}^3/\text{min}$) 28°C 62%
 Note: Electrostatic elimination speed test: neutralization time (S) from 1000V to 100V

Features

- Adjustable speed of fan can generate large-area ion airflow.
- Stable and adjustable ion balance.
- Built-in emitter cleaner, easy cleaning.
- Built-in safe and low power heater can generate warm airflow.

Specifications

Model	QUICK 441B
Power (during heating)	300W
Output voltage	AC 5.6 KV
Ion balance	Adjusted to be within $\pm 10\text{V}$ before delivery (30 cm away from the panel)
Blast capacity	$\leq 3.3 \text{ m}^3/\text{min}$
Ozone generating amount	0.03 ppm or below (15 cm away from the center of air outlet)
Operation environment	60- 70% RH
Effective range	900 x 1800 (mm)
Filter device	Optional
Overall dimensions	390x210x190 (mm)
Weight	About 7.5kg

Note: The length of air outlet and number of air outlets can be customized according to the customer's requirements.

Practical picture

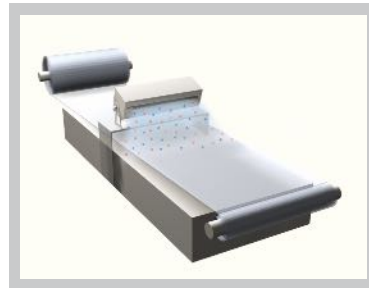

Thin film production line, injection moulding

STATIC ELIMINATOR

QUICK/442

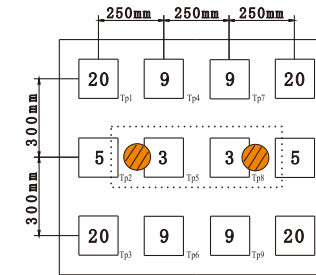

Features

- Large area of ionizing air.
- Stable and adjustable ion balance.
- Suspended type, save space.

Specifications

Model	QUICK442-2	QUICK442-3
Max. consumption power	50W	100W
Output voltage	AC 5.6 KV	AC 5.6 KV
Ion balance	Adjusted to be within $\pm 15\text{V}$ before delivery (45 cm away from the panel)	
Air Volume	$\leq 1.2 - 2.4 \text{ m}^3/\text{min}$	$\leq 1.2 - 2.4 \text{ m}^3/\text{min}$
Ozone generating amount	0.03 ppm or below (150 mm away from the center of air outlet)	
Operation temperature	0-50 $^\circ\text{C}$	0-50 $^\circ\text{C}$
Effective range	750x1500 (mm)	600x1600 (mm)
Filter device	Optional	Optional
Overall dimensions	630 x170 x 90 (mm)	1086 x170 x 90 (mm)
Weight	About 7.0 Kg	About 11Kg

Note: The length of air outlet and number of air outlets can be customized according to the customer's requirements. With the stainless steel enclosure, QUICK442-2D is suitable to the dust-free room and clean workshop.

QUICK/442-3 Static Eliminator

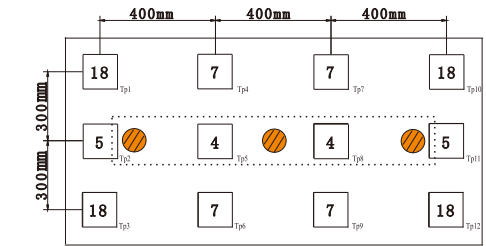

Test diagram

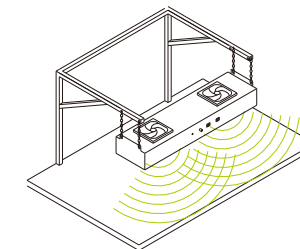

Note: Test diagram of suspended ion fan
 Note: Tested at the vertical distance of 45 cm from the air outlet

Practical picture

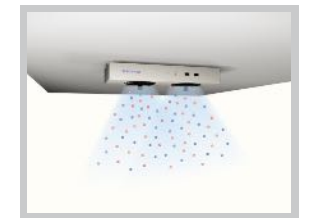

ESD control area of dust-free room

IONIZING AIR GUN

QUICK/445F Ionizing air snake



QUICK445F

Features

- Ion balance: $\pm 10V$, neutralize static charges rapidly.
- Stable ion balance, adjust outside, easy operation.
- Built-in silencer, low noise.
- Capacitor coupling high voltage design, safe and reliable.
- Air volume adjustable.
- QUICK446F-II: Suits two loads.

Specifications

Model	Supply voltage	Output voltage	Secondary short-circuit current	Rated power
QUICK 446F	AC 220V	AC 7 KV	< 3 mA	15W

Electrostatic Elimination Time Test

Air pressure	Distance	15cm	30cm	45cm	60cm
0.2Mpa	Electrostatic elimination time (S)	0.9S	1.3S	1.7S	2.1S
	Ion balance (V)	1.0S	1.4S	2.1S	2.9S
		-1V	+5V	+6V	0V
0.4Mpa	Electrostatic elimination time (S)	0.8S	1.0S	1.3S	1.9S
	Ion balance (V)	1.0S	1.3S	2.0S	2.5S
		0V	+1V	+1V	0V
0.6Mpa	Electrostatic elimination time (S)	0.8S	1.0S	1.4S	1.5S
	Ion balance (V)	0.9S	1.4S	1.8S	2.7S
		-2V	-4V	+6V	-14V

Notes: Environment: 22 °C, humidity 60-70%, test method determined according to ANSI/ EOS/ ESD- S3.1- 1991; The time required for the ion dropping from 1000V to 100V and ion balance voltage; When operating under the air pressure of 0.7 Mpa, its noise is less than 80 dB.

QUICK/446F High Voltage Power Supply



QUICK446F



QUICK446F-II

STATIC ELIMINATOR

QUICK/4456EF Ionizing air snake



Features

- Stable ion balance, external adjustment, simple and convenient.
- With the ion balance up to $\pm 10V$, it can quickly eliminate the static electricity charged on the object.
- Built-in silencing system, low noise, high voltage in capacity coupling, safe and reliable.
- The air source and high voltage can be simultaneously controlled by the optoelectronic switch or pedal switch.
- With clamp design, the electrostatic elimination direction can be adjusted flexibly.
- 4456EF is in integrated design, saving space and long high-voltage wires.
- 446EF-II can provide two circuits of load simultaneously.

QUICK/445EF Ionizing Air Snake



QUICK445EF



QUICK445AF

QUICK/446EF Power Supply



QUICK446EF



QUICK446EF-II

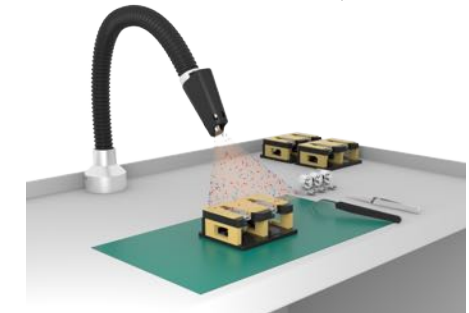

Specifications

Model	QUICK445EF	High-Voltage Power Supply	QUICK446EF
Air Requirements	Clean and dry air, 0.1-0.7MPa	High-Voltage Output	7KV ^{±40%}
Air Connector	6×8mm PU pipe	Sub Short-Circuit Current	<3mA
High-Voltage Input	7KVAC ^{±40%} 50Hz	Power	<30W
Effective Static Discharge Distance	Within 1000mm	Numbers of Load	1

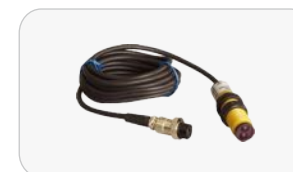

Photoelectric Switch



Pedal Switch



Photoelectric Switch Fixing

STATIC PROTECTION SERIES

QUICK/445D Ionizing Air Gun

QUICK/446 High Voltage Power Supply



QUICK445D



QUICK446

Features

- Compact design, easy operation.
- Neutralize static charges rapidly, remove fine sensitive components and materials easier.
- Built-in regulator of remnant voltage, adjust ion balance quickly and effectively.
- Two ionizing air guns can be connected to QUICK446 high-voltage power supply at the same time.
- Purchase separately.

Specifications

Frequency of QUICK446	50Hz/60Hz
Secondary Output Voltage	AC 4.0KV
Power Consumption	4W
Dimensions	165(L)×103(W)×115(H)mm
Weight	2.0kg

- * Ambient conditions: About 0-50°C , 60-70% RH.
- * Life expectancy: About 10000 hours (based on 8h/d, 250d/y, around 5 years).

Time for Static Neutralizing

Pressure	Air Flow	Decay Time	Noise
0.2Mpa	0.06m ³ /min	1.2s	≤71dB
0.4Mpa	0.12 m ³ /min	0.6s	≤88dB
0.6Mpa	0.18 m ³ /min	0.4s	≤95dB
0.7Mpa	0.20 m ³ /min	0.3s	≤98dB

- * Testing distance: 15cm from the outlet of the air gun.

Practical Diagram

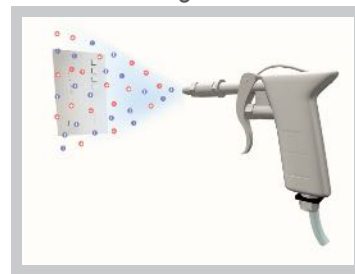

Remove Dust Before Painting

STATIC PROTECTION SERIES

QUICK/445E Ionizing Air Snake

QUICK/446E High Voltage Power Supply

Features

- Nozzle adjustable.
- Controlled by pedal switch, can control the airflow and output ion high voltage simultaneously.
- Built-in regulator of remnant voltage, adjust ion balance quickly and effectively.
- Save energy, prolong lifetime.
- Photoelectric switch optional.



QUICK445E



QUICK446E

Practical Diagram



Eliminate the static charges and remove the dust on the precise parts of an apparatus"

Specifications

Input Voltage	Secondary Output Voltage	Power	Dimensions	Weight
AC 220V	AC 4.0KV	20W	154(L)×148(W)×82(H)mm	Around 2.8kg

- * The standard length of QUICK445E snake tube is 600mm. It also can be customized as per requirements.
- * The length of QUICK445E high-voltage wire is 3M.

Time for Static Neutralizing

Pressure	Air flow	Decay time	Noise
0.2Mpa	0.06m ³ /min	1.2s	≤71dB
0.4Mpa	0.12 m ³ /min	0.6s	≤88dB
0.6Mpa	0.18 m ³ /min	0.4s	≤95dB
0.7Mpa	0.20 m ³ /min	0.3s	≤98dB

- * Test distance: 15cm from the outlet of air gun.

STATIC METER

QUICK/431 Static Meter

Features

- Four working modes available.
- Two measuring functions: a) Static measurement; b) Ion balance voltage measurement.
- Two potential measurement modes: a) Instantaneous value; b) Peak value.
- Easy operation, test distance can be adjusted conveniently.
- Pocket design, easy to carry.

Applications



Measuring the electric charge of products such as thin film and resin.
 Measuring the electric charge on the production line.
 Measuring the electric charge around the devices.
 Measuring the ion balance of electrostatic eliminator.



Specifications

Power supply	DC 9V battery
Display method	LCD display and synchronous display of step order and measuring range
Electrostatic measuring range	Low range: 0- ± 1.50 KV, high range: 1- ± 22.0 KV (auto switch of high and low ranges)
Ion balance test range	Test range 0- ± 220V
Standard measuring distance	250 mm (± 0.5 mm)
Measurement accuracy	±10% + 1 character
Standby current	Standby current < 3 uA
Operating current	< 15 mA
Operating environment	0 °C - 50 °C, RH: 0 % -80%
Shell	Anti-static design
Overall dimensions	125×70×25 (mm)
Weight	About 0.20 Kg (including battery and ion balance test plate)

CHARGE PLATE MONITOR

QUICK/432 Static Meter



Test Diagram

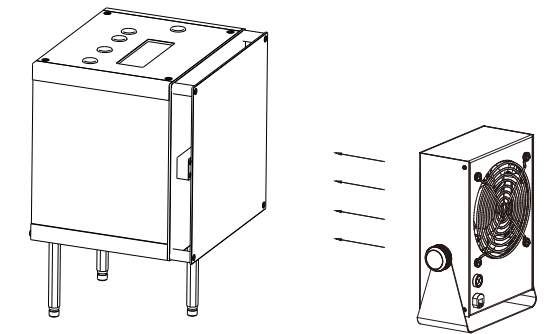

Features

- Use non-contact sensor, high test resistance and precision, stable.
- Four working modes function, can be used as a voltmeter, parameters of four working modes can be set accordingly.
- With 'PASS' function, parameters of which can be set as per product requirements, the unit will alarm if test fails.
- With data recording function, can record 100 groups of data for further reference.
- Personality setting, select related functions as per requirements.
- Built-in chargeable battery, it can be used even no external power supply.
- Easy operation, convenient to carry.

Specifications

Voltage measuring range	0 - ± 1000 V
Voltage accuracy	± (5% +1 digit)
Time accuracy	1%
Test range	0 - 600 S
External power supply	DC 12V 400 mA
Built-in rechargeable battery	8.4 V (Li)
Display	LCD display, display screen size: 100 * 24 (mm)
Standby time	600 s
Ambient temperature	0- 40 °C
Relative humidity	0-70%
Test polar plate	152 * 152 (mm)
Overall dimensions	152(L) * 152(W) * 225(H) (mm)
Weight	About 1.76 Kg

COMB TESTER

QUICK/492G

Features

- Two testing modes available, individual test and comprehensive test. Individual test: Test the wear status of wrist strap, single foot or both feet (foot ring, conducting shoes and anti-static shoes) separately. Comprehensive test: Test the wear status of wrist strap and both feet (foot ring conducting shoes and anti-static shoes) simultaneously.
- With door control system signal: The tester can output a signal to door control system and prevent people from entering anti-static places freely.
- Combo tester uses mini current to test, stable testing and accurate data.
- The output signal of controlling door system is stable, easy operate and widely use.
- Can be connected to PC by RS485, record the date for controlling and checking.
- Extended range of foot ring: 100KΩ-1GΩ.

Practical Diagram

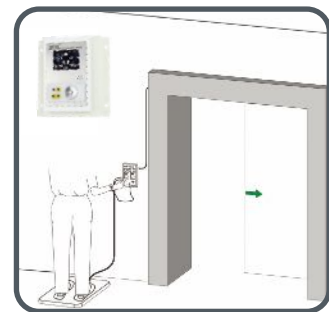

Connection with door access system



Specifications

Power supply	Power supplied by AC coupling adaptor (8- 12 VDC) Voltage ≤ 400 V (peak value, DC or AC)
Contact switch output	Switching current ≤ 100 mA, contact resistance: about 30 Ω Different ways of outputting qualified and un-qualified signals
Accuracy	Wrist strap ± 10% Footwear ± 10%
Communication	RS 485
Overall dimensions	162x102x28 (mm)
Weight	About 8.9kg

SURFACE RESISTANCE TESTER

QUICK/499D

Features

- Measure the surface coefficient and grounding resistance of object, as well as the anti-static and insulating material.
- Digital design, high precision.
- Compact design, easy for carry and operation.

Specifications

Measuring range	$10^{2.5} - 10^{12.5} \Omega$
Power supply	9V battery
Resolution	0.1 digit
Accuracy	± 0.5 digit
Operating environment	0 °C - 49 °C, RH: 0 % -80%
Overall dimensions	130x72x35 (mm)
Weight	About 0.2 Kg (including battery)



Rear View

DISPENSING CONTROLLER

QUICK/982B



Operation Diagram



Features

- Time of each injection controlled by timer, dispensing at regular time and quantity to ensure same glue quantity each time.
- Select right nozzles, set right injection time and pressure, each injection time and quantity can be changed.
- Can be used to inject liquid or paste, include red gel, yellow gel, epoxy resin, solder, silica gel, soldering fluid etc.
- Pedal switch and manual control modes available, manual mode is more suitable for stand-up staff.
- Various barrels and nozzles are available.

Specifications

Dispensing method	16 methods freely settable including manual timing and automatic timing
Dispensing time	0.01 S – 99.99 S adjustable
Interval time	0.1 S – 9.9 S adjustable
Repeated stability	± 0.05%
Internal operating voltage	DC 24 V
Minimum glue dripping amount	0.01 ml
Air pressure input	0.25 – 0.7 MPa (2.5 – 7 kg)
Air pressure output	0.01 – 0.7 MPa (1- 7 kg)
Dimension(W×H×D)	238x150x 60 (mm)
Weight	About 1.7 Kg

DISPENSING CONTROLLER

QUICK/982E



Features

- TFT3.3 inch LCD display, data dynamic and intuitive.
 - Injection time controlled by the timer, regular and quantitative dispensing.
 - Adjust the air pressure, select the appropriate time and needle, the amount and time of each injection can be changed to meet different needs.
 - Dispensing materials: red gum, yellow gum, epoxy resin, solder paste, silicon glue and flux etc.
 - Two methods optional: pedal switch and manual control, hand switch available.
 - Various types of syringes and needles available.
 - Dispensing data readable by PC communication.
- Can be used for online control of automated industry.

Specifications

Dispensing method	Manual timing and automatic timing
Dispensing time	0.01 S – 99.99 S adjustable
Interval time	0.1 S – 9.9 S adjustable
Repeated stability	± 0.05%
Internal operating voltage	DC 24 V
Minimum glue dripping amount	0.01 ml
Air pressure input	0 – 0.7 MPa (2.5 – 7 kg)
Air pressure output	0 – 0.7 MPa (1- 7 kg)
Dimension(W×H×D)	205x200x 76 (mm)
Weight	About 2.8 Kg