

**Ready At Any Time.
An Overview Of Pneumatic Cylinders**

AVENTICS™ Pneumatic Cylinders
Application-oriented cylinder technology.
Competent and well-designed down to the last detail.



Competent and well-designed down to the last detail – application-oriented cylinder technology

04 Product overview

- 06 Mini and round cylinders
- 10 Short-stroke and compact cylinders
- 14 Profile and tie rod cylinders
- 18 Rodless cylinders
- 22 Handling technology
- 26 Customized solutions
- 27 Special cylinders

28 Cylinder accessories

32 Cylinder sensors

34 Consulting, CylinderFinder

35 Glossary

36 Engineering Tools

37 Catalog range

Perfection is our business

Our customers are demanding. They expect the highest performance from us and our solutions. And that is exactly what we want – because what our customers expect of us is what we expect of ourselves. That applies to all our services, as well as to every single element in our product range – right down to the last detail.

Our comprehensive range of perfected cylinder technology meets the demands of modern automation technology and offers suitable solutions for all applications, with all components reflecting our product philosophy of consistently high standards in quality and design.

- Functionality
- Modularity
- Quality and design

And whatever we do, the benefit for the customer is the focus of all our work – in advice and support, research and development, design and production. An absolute practice and solution orientation – but with an eye on trendsetting innovations that open up new possibilities. Function integration, component reduction, alternative materials management – those are just a few of the trends in modern product development that create future advantages and additional benefits that you can expect from Emerson as a global supplier of automation technology.



Excellently equipped, both outside and inside: from the broad range of electronic and pneumatic connection technologies through the safe and precisely-controlled movements right up to reliable and exact sensors.

The right cylinder solution for every application. With all options for specific tasks

Insight – overview – outlook

This brochure is a fundamental orientation aid for selecting suitable products and provides information on the main features and fields of application of the cylinders. A summary of the program at the end of the brochure serves as an introduction to our detailed catalog.

A comprehensive program with a clear platform strategy

The modern applications for pneumatic cylinders dictate the portfolio. A perfect cylinder has to be not only well designed, easy to integrate, strong, durable, and reliable, but also able to function both powerfully and sensitively and able to adapt to a wide variety of demands – it has to prove its high efficiency and cost-effectiveness day after day. Our product range of pneumatic cylinders meets these demands in every respect and is just as versatile as it is comprehensive.

The spectrum ranges from extremely compact cylinders for small handling applications to larger cylinders for the most powerful tasks, as well as rodless cylinders with guide slides for long strokes right up to ISO cylinders with a clean design.

- Cylinders with piston rods
- Rodless cylinders
- Handling technology

Cylinder selection made easy

With so many cylinder series on offer, there is one question: which cylinder is the right one for my specific task? Emerson has the answer. Our experienced consultants are always on hand to answer your questions, and our latest Engineering Tool, the AVENTICS CylinderFinder, is available around the clock for basic considerations.

Page 34

Mini and round cylinders

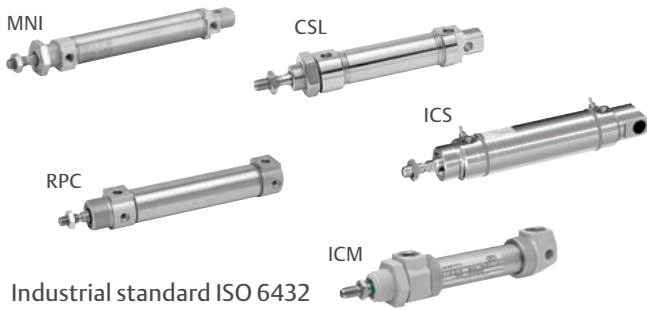

Industrial standard ISO 6432
Pages 6-9

Short-stroke and compact cylinders



Industrial standard ISO 21287 / ISO 15524 / NFE 49004
Pages 10-13

Profile and tie rod cylinders

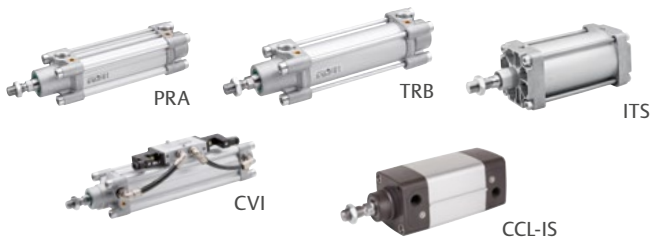

Industrial standard ISO 15552
Pages 14-17

Rodless cylinders

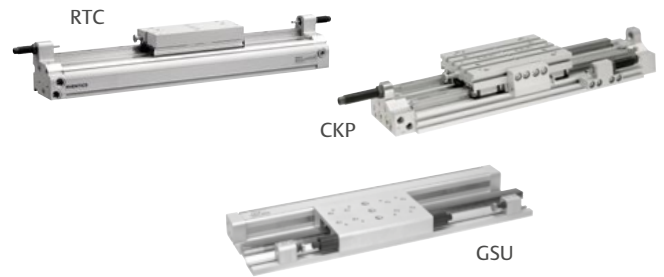

Pages 18-21

Handling technology

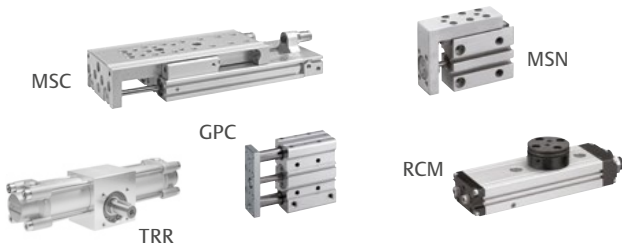

Pages 22-25

Special cylinders



Page 26

Accessories



Pages 28-34

The mini range for maxi applications. Mini and round cylinders

Don't underestimate us! Ultra-compact integrated power and intelligence – our mini powerhouses. The continued trend towards product and component miniaturization creates an ever-growing number of applications for our tiny all-rounders. Round cylinders in our signature Clean design are the perfect solution for applications with the strictest hygienic requirements.

Series	MNI	RPC	ICM	CSL	ICS
Corrosion resistance	○	○	+	++	++
Temperature range	+	+	○	+	○
Variety of versions	○	+	○	++	○
ATEX	++			+	++
Easy to clean	○	○	+	++	++

++ Highly recommended + Recommended ○ Suitable

Ideal cylinders for small handling and food industry applications

Minimal dimensions are not the only feature that make mini and round cylinders the natural choice for small handling. Excellent precision, infinitely adjustable force control and a low net weight are just some of the added benefits for our users in a wide variety of industries.

Our hygienically designed round cylinders are always the first choice for applications that require optimal component cleaning or corrosion protection and heat resistance due to the use of aggressive media. The enormous breadth of our product range, including numerous versions, enable tailor-made solutions for specific applications.

MNI series (ISO 6432)

Our proven range of cylinders for general machine construction. This design is characterized by its robustness and long service life. A cylinder for users and developers who rely on the greatest efficiency.

Ø 10 - 25 mm



MNI



The cylinder series cover the entire spectrum of applications Mini and round cylinders from the different series in our program with their specific characteristics, strengths and properties are designed for special applications and industry solutions.

RPC series

The round cylinders from the RPC series offer a wide variety of connection options. They are easy to clean and suitable for packaging applications in the food industry thanks to food-grade lubricants, in addition to standard applications.

Ø 32 - 63 mm



RPC

ICM series (ISO 6432)

Mini cylinders from the ICM series offer high corrosion resistance and are a reliable, cost-efficient solution – even in harsh environments. The cylinder tube and piston rod are made of stainless steel, the cylinder covers are fashioned from a high-quality polymer.

Ø 8 - 32 mm



ICM

CSL-RD series (ISO 6432)

Round cylinder series CSL-RD Stainless Line, optionally in hygienic design or as an ISO version. The CSL-RD has a smooth profile and low surface roughness, and can be used with food-grade lubricants and sealings.

Ø 16 - 25 mm



CSL

ICS series

The hygienic design of the ICS with smooth surfaces, interlocking seals and cushioning screws prevents dirt pockets from the outset and guarantees optimum cleaning conditions.

Ø 32 - 100 mm



ICS

Overview of variants – basic versions and optional equipment. Mini and round cylinders

Stainless steel mini cylinders: specialized in food industry applications
Example: CSL-RD hygienic design series, size Ø 20 mm

- 1 | Scraper without an undercut for FRE variant: no possibility for dirt to accumulate, FDA-compliant in accordance with 21 CFR 177.2600
- 2 | Plastic bearing bush: PEEK high-performance plastic, smooth running, long service life
- 3 | Smooth surfaces: stainless steel AISI 304, especially smooth surfaces thanks to electropolishing (Ra < 0.6 µm)
- 4 | Grease for food applications: NSF-H1-registered, FDA-compliant in accordance with 21 CFR 178.3570
- 5 | Clean tube/cover connection: optimized rolling geometry, sharp edges/nuts are avoided
- 6 | Cushioning screw: cushioning energy up to 2.7 J at 2 m/s, precisely adjustable via 2.5 mm hexagon head for all diameters

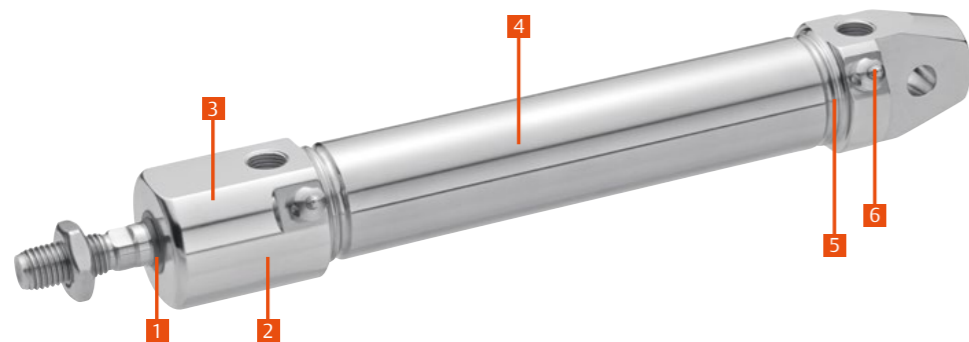

Series	MNI		RPC		CSL-RD		ICM		ICS		
	with magnetic piston	without magnetic piston	with magnetic piston	without magnetic piston	with magnetic piston	without magnetic piston	with magnetic piston	without magnetic piston	with magnetic piston	without magnetic piston	
	– With elastic cushioning										
	– With pneumatic cushioning										
	Heat-resistant up to		120 °C	120 °C	80 °C	120 °C	120 °C	120 °C	70 °C	70 °C	80 °C
ISO	Installation standard ISO 6432		✓	✓	✓	✓	✓	✓	✓	✓	✓
	Stainless steel						✓	✓	✓	✓	✓
	Single-acting		✓	✓	(✓)		✓	✓		✓	
	Piston rod extension		✓	✓	✓	✓	✓	✓	(✓)	(✓)	✓
	Through piston rod		✓	✓	✓	(✓)		(✓)	(✓)		✓
	Optional stroke length		✓	✓	✓	✓	✓	✓			✓
	Non-rotating, without front plate			✓							
	ATEX zone 1/21 cat. 2G/D		✓	✓	✓	✓	(✓)	(✓)	✓	✓	
	Food-grade grease NSF-H1						✓	✓	✓	✓	✓
	Hygienic design						✓	✓			✓
	Short type					✓		✓	(✓)		✓
	Adjusted cushioning						✓				
	Distance measuring system		✓	✓							
	Rotated end covers						(✓)	(✓)		✓	✓
	Piston diameter		10 - 25 mm		32 - 63 mm		16 - 25 mm		8 - 32 mm		32 - 100 mm
	Stroke range		10 - 1,300 mm		25 - 1,200 mm		25 - 1,300 mm		25 - 400 mm		1 - 1,600 mm

On request

Short-stroke and compact cylinders. When things get tight, our compacts come out strong

Save where you can!

There is always room for our compact cylinders. Save on installation space and costs during the design phase, because our short-stroke and compact cylinder series make it easy to come up with cost-efficient machine constructions. And all that without having to compromise on precision, reliability and innovative technology. The products from our sophisticated program are backed by the experience from many years of cooperation with users in our core industries. They help to save without making compromises. The comprehensive program with large stroke ranges and piston diameters makes the use of our cylinder series the logical choice in practically any machine environment.

Concentrated power in a minimum of space

With three different product standards in sizes from 8 mm to 100 mm piston diameter in a very wide range of variants, our short-stroke and compact cylinder program is one of the largest and most varied on the market worldwide. Suitable for strokes from 4 mm. Each series also offers non-rotating versions with a mounted front plate.

Series	CCI	CCL-IC	SSI	KPZ	KHZ
Compactness	+	+	++	+	++
Variety of versions	++	+	+	++	+
Standard	ISO 21287	ISO 21287	ISO 15524	NFE 49004	none
Diameter range	+	+	++	+	++
Stroke range	++	++	+	++	+
Sensor installation	++	○	++	++	+
Mounting options	++	+	+	++	○

++ Highly recommended + Recommended ○ Suitable

CCI series (ISO 21287)

CCI means: innovative, compact construction and an easy-to-clean design. The CCI is ideal for long strokes and increased requirements for optimized cycle times and moving masses. The sensors can be installed quickly and easily on all sides and over the entire stroke range.

Ø 16 - 100 mm



CCI with Sensor



They get very little room to work, but have to move a lot in the tightest spaces. Do a lot with very little – those are the ideal specifications for the use of our miniature power packs. In the strictest sense of the word you can say here: less is more.

Serie CCL-IC (ISO 21287)

The series CCL-IC with their compact and hygienic design can be used in a wide range of applications. Their smooth surface together with their materials, such as anodized aluminum, stainless steel, and NSF-H1 lubricants, make the cylinder ideal for the demanding requirements in the food and beverage industry.



CCL-IC

SSI series (ISO 15524)

SSI – the short stroke cylinder in accordance with the latest ISO standard 15524. The cylinders are particularly compact and up to 30% lighter than comparable cylinders thanks to weight-optimized profiles and fewer components. In addition, they provide a high degree of flexibility in sensor assembly and extremely effective elastic cushioning.

Ø 12 - 100 mm



SSI non-rotating

KPZ series (NFE 49004)

Series KPZ compact cylinders offer a wide variety of variants. They can be used very flexibly and are suitable for a multitude of applications thanks to their sizing based on the widely used standard NFE 49 004.

Ø 16 - 100 mm



KPZ non-rotating

KHZ series

The non-standard short-stroke cylinders in the KHZ series are available from a piston diameter of 8 mm. They are ideal for tight installation spaces and ensure easy, safe integration in machinery.

Ø 8 - 100 mm



KHZ

Overview of variants – basic versions and optional equipment. Short-stroke and compact cylinders

Lightweight, fine-tuned details, easy-to-mount and highly compatible:
Example: SSI series with front plate, size Ø 20 mm

- 1 | Compatible: complying with standards and compatible with many existing applications on the market
- 2 | Low noise and vibrations: up to 60% better cushioning properties than comparable products as standard
- 3 | Variations: configurator, intermediate strokes, many variants and analog distance measurement available
- 4 | Easy mounting: hex flats
- 5 | Easy mounting: universal mounting concept with 4 mounting options for all diameters
- 6 | Lightweight: up to 30% lighter than comparable products due to material-optimized profile
- 7 | Space-saving: fully insertable, direct drop-in sensors, customized intermediate stroke lengths without spacer disks

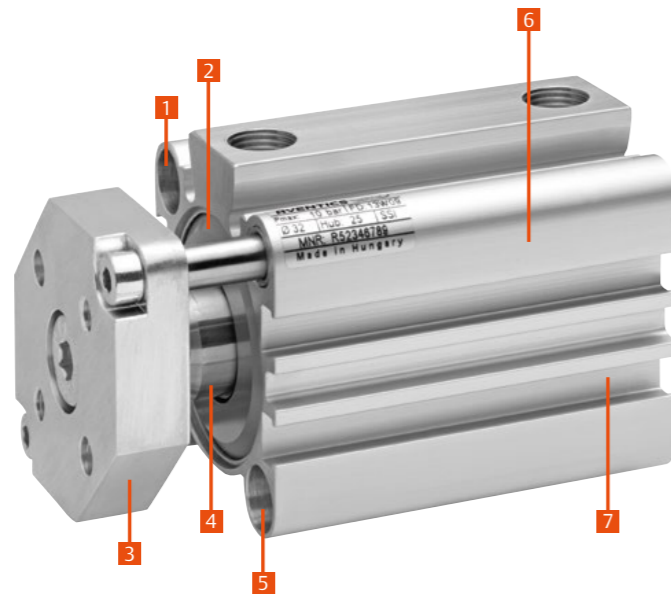

Series		CCI		CCL-IC *		SSI		KPZ		KHZ			
Version		with magnetic piston		with magnetic piston		with magnetic piston		without magnetic piston		with magnetic piston		without magnetic piston	
	– Double-acting – Non-rotating, with front plate												
	Heat-resistant up to	120 °C	120 °C	120 °C	80 °C	80 °C	80 °C	120 °C	120 °C	80 °C	80 °C	80 °C	80 °C
ISO	Installation standard	ISO 21287		ISO 21287	ISO 15524								
	Elastic cushioning	✓	✓	✓	✓	✓	✓	✓	✓	✓	✓	✓	✓
	Single-acting	✓		✓	✓			✓		✓		✓	
	Internal thread External thread	✓	✓	✓	✓			✓	✓	✓	✓	✓	✓
	Piston rod extension	✓	✓	✓	✓			✓	✓				
	Through piston rod	✓	✓	✓	✓			✓	✓	✓			
	Optional stroke length	✓	(✓)	✓	✓	✓	✓	✓	✓	(✓)			
	Non-rotating, without front plate		✓						✓				
	ATEX zone 1/21 cat. 2G/D	✓		✓				✓					
	Distance measuring system	✓	✓	✓	✓	✓		✓	✓				
	Piston diameter	16 - 100 mm		16 - 100 mm		12 - 100 mm		16 - 100 mm		8 - 100 mm			
	Stroke range	5 - 500 mm		5 - 500 mm		5 - 150 mm		5 - 500 mm		4 - 100 mm			

(✓) On request * Clean Design and food-grade grease NSF-H1

Sturdy and reliable – quality for standard applications. Profile and tie rod cylinders

Universal solutions in numerous industries

With sizes from 25 mm to 320 mm piston diameter, the profile and tie rod cylinders in these series cover the entire range of applications. Our customers rely on the indestructible quality of our cylinder solutions in machine and system construction with tasks requiring high precision and regulated force, as well as in industries where enormous forces are needed.

Standardized classic

Innumerable design variants and sizes in the different cylinder series make it easy for the user to select the most suitable cylinder solutions for his specific application. The broad range of cylinders allows the cylinders to be specifically chosen, not only the basis of function and quality, but also under strict cost considerations.

Series	PRA	TRB	ITS	CCL-IS
Resistance	○	○	+	+
Easy to clean	○	○	○	++
Compactness	++	○	○	+
Variety of versions	+	++	+	○
Configurability	++	++	++	++
Temperature resistance	++	++	++	+

++ Highly recommended + Recommended ○ Suitable

PRA series (ISO 15552)

The PRA cylinder program is based on a compactly designed profile with integrated sensor nuts. Thanks to incomparable pneumatic cushioning, it is no problem for the PRA cylinders to transform load into speed and strain into control.

Ø 32 - 125 mm



PRA



Standardized to international norms and with an outstanding profile. Our profile and tie rod cylinders, in accordance with ISO 15552, have stood the test of decades of user-oriented practice and have established a firm position in professional pneumatics applications. Sturdy and reliable – and all that worldwide.

TRB series (ISO 15552)

TRB cylinders are among the most frequently employed cylinders in the process industry, automotive industry, and wood processing industry. The series meets every wish for product variety, durability and adaptability to existing processes.

Ø 32 - 125 mm



TRB

ITS series (ISO 15552)

The cylinders in the ITS series are the “big brothers” of the TRB series cylinders. They are always specifically used when extremely large masses are involved that have to be moved efficiently and under control with the familiar ease of operation. Thanks to the versatility of the modular sealing system, the ITS can be optimally adapted to every application.

Ø 160 - 320 mm



ITS with modular scraper (integrated)

CCL-IS series (ISO 15552)

This cylinder in clean design is produced specifically for packaging applications in the food industry. It is characterized by practical sensor mountings and its hygienic design that combines simple cleaning with low maintenance.

Ø 25 - 125 mm



CCL-IS

CVI series (ISO 15552)

Typical uses for the CVI series are open/close functions such as flap controls and spool applications. With two ISO cylinder series and five freely combinable valve series, you can custom-configure individual units online.

Ø 32 - 125 mm



Cylinder valve unit CVI

Large variety with perfect equipment details. Profile and tie rod cylinders

Example: ITS series ISO cylinder, size Ø 250 mm

- 1 | Modular scraper
- 2 | Stainless steel piston rod as standard
- 3 | Material-optimized aluminum, die-cast or aluminum chill casting
- 4 | Elastic or pneumatic cushioning system
- 5 | Aluminum body anodized
- 6 | Stainless steel tie rod as standard



Series		PRA/TRB				ITS				CCL-IS *
Version		with magnetic piston		without magnetic piston		with magnetic piston		without magnetic piston		with magnetic piston
	- With elastic cushioning									
	- With pneumatic cushioning									
	Heat-resistant up to	120 °C	120 °C	150 °C	150 °C	120 °C	120 °C	150 °C	120 °C	120 °C
	Improved corrosion resistance		✓							
	Piston rod extension	✓	✓	✓	✓	✓	✓	✓	✓	✓
	Through piston rod	✓	✓	✓	✓	✓	✓	✓	✓	✓
	Non-rotating, without front plate		✓							
	Modular scraper	✓	✓	✓	✓	✓	✓	✓	✓	✓
	Trunnion mounting	✓	✓	✓	✓	✓	✓	✓	✓	
	Smooth-running	PRA	PRA	TRB	TRB					
	Zone 21, category 2 G/D** Zone 22, category 3 G/D**		✓			✓	✓	✓	✓	
	Rotated end covers	✓	✓	✓	✓	✓	✓	✓	✓	✓
	Holding unit/dynamic brake	✓	✓	✓	✓					
	Holding unit	✓	✓	✓	✓					(✓)
	Distance measuring system	✓	✓	✓	✓	✓	✓	✓	✓	✓
	With mounted valve**	✓	✓	✓	✓	✓	✓	✓	✓	(✓)
	Piston diameter	32 - 125 mm				160 - 320 mm				25 - 125 mm
	Stroke range	25 - 2,800 mm				25 - 2,700 mm				25 - 2,800 mm

(✓) On request * Clean Design and food-grade grease NSF-H1 ** Not for order in combination with heat-resistant version

Precise guidance, large distances, enormous flexibility – and “Easy-2-Combine”.

Rodless cylinders

The ideal shuttle service: operates exactly as required. Quick, direct, without detours and always on time. The rodless cylinder concept impresses with absolute repetitive precision, functions highly dynamically with reliable accuracy and is thereby highly cost-effective.

The basis for numerous handling applications

Thanks to their high functionality and drive force in a minimum of space and the wide range of sizes and design variants, the rodless cylinders and slide units are predestined for use as basic modules in handling technology. The great flexibility of the pneumatic connections and mechanical interfaces facilitates machine design and integration into existing configurations. Perfect function integration and practical details, such as size-optimized connections and ducts and optimized cushioning systems, are further guarantees of safe and reliable continuous operation.

The wide range of design variants with different connection options allow targeted use in automated handling technology in many industries.

Precision and speed for long strokes

The rodless cylinders permit an optimum stroke length in relation to their size. This saves space and facilitates machine design. The application range covers piston diameters from 16 mm to 80 mm and stroke lengths up to 9,900 mm. A wide speed range of 0.05 m/s to 5 m/s can be achieved with extremely high repetitive precision.

Series	RTC-BV	RTC-SB	RTC-CG	RTC-HD	CKP	GSU
Load capacity	○	+	+	++	++	+
Precision		○	+	+	++	++
Easy-2-Combine interface			++	++	++	++
Longer strokes	++	++	○	+	+	
Stroke limitation with shock absorbers	○	++	++	++	++	++

++ Highly recommended + Recommended ○ Suitable



Emerson focuses on Easy-2-Combine interfaces that do not require transition plates and thus enable simplified machine designs.

RTC series

The compact form and unique properties of the RTC series open up completely new application possibilities. Compared with a round piston, the oval piston can withstand higher loads and torques. The slide and piston as a single unit mean high load capacity and reliability. High load capacity with small cylinder dimensions enables a simplified and compact machine design. The RTC series program is based on four variants with different key strengths. For large loads, very precise movement and positioning and a wide range of speeds. Stroke lengths and porting available in metric and inch dimensions.



CKP series

CKP series cylinders are particularly suitable for moving heavy loads in machine environments with limited space. They are equipped with integrated pneumatic cushioning and ensure extremely precise, sturdy guidance with high repetitive precision.



GSU series

This high-performance slide unit forms a sturdy basis for a large number of handling applications. The stroke length and position can be set variably over the entire length of the slide unit – individually from both sides, further underlining the enormous flexibility for installation. The very low overall height and an option for ventilation and exhaust on one side further expand the integration possibilities.



Overview of variants – basic versions and equipment details. Rodless cylinders

Example: RTC series

Complete product range for numerous tasks and special applications

- 1 | Hightech sealing and lubrication for a wide range of speeds with best-in-class tightness, long service life and high reliability
- 2 | One-piece slide and pistons: increased strength, reduced installation space
- 3 | Oval pistons: an oval piston design permits unusually high loads and bending moments, as well as an even compacter machine design
- 4 | Easy-2-Combine interface: simplified machine design and reduced mounting effort saves time and money

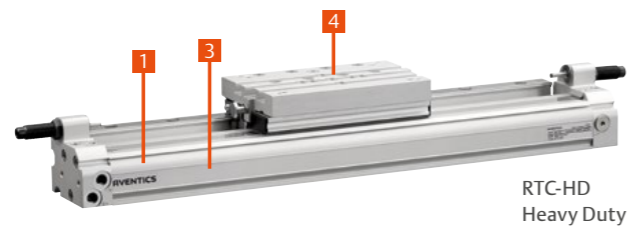
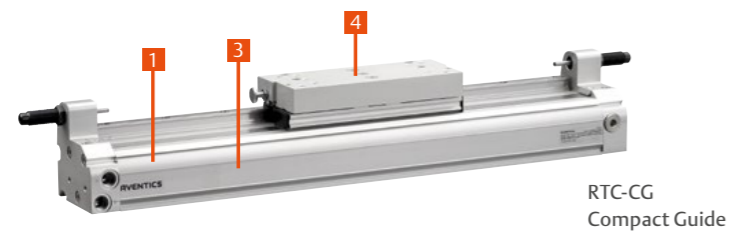
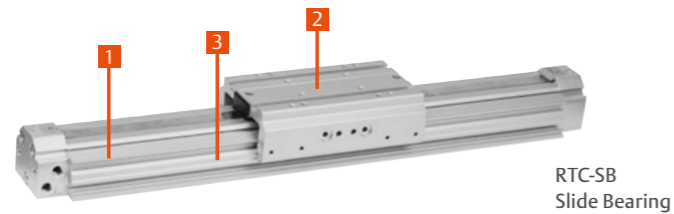

Series		RTC-BV	RTC-SB	RTC-CG	RTC-HD	CKP	GSU
Version		with magnetic piston				with magnetic piston	with magnetic piston
	– with pneumatic cushioning						
	– with hydraulic cushioning						
	Adjustable cushioning	✓	✓	✓	✓	✓	
	Oval piston	✓	✓	✓	✓	✓	✓
	Ball rail guide			✓	✓	✓	✓
	Adjustable stroke limitation		✓	✓	✓	✓	✓
	Easy-2-Combine interface			✓	✓	✓	✓
	Piston diameter	16 - 80 mm	25 - 40 mm	16 - 40 mm	16 - 63 mm	16 - 32 mm	16 - 25 mm
	Stroke range	100 - 9,900 mm	100 - 9,900 mm	200 - 2,000 mm	200 - 4,300 mm	100 - 3,700 mm	200 - 1,000 mm

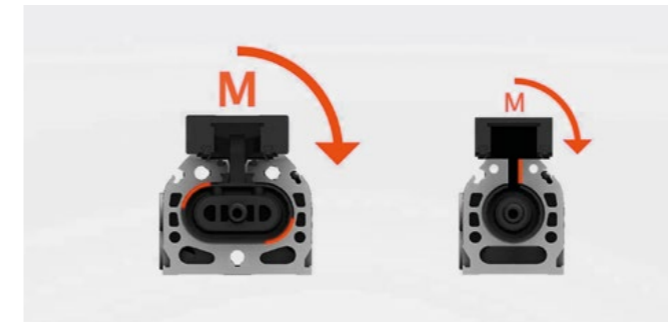

Oval piston provides an optimal distribution of transverse forces. Permanently connected to the slide, the oval piston can withstand higher loads and moments than the round piston. Users achieve the same performance with far more compact cylinders, which cuts down on weight and costs.

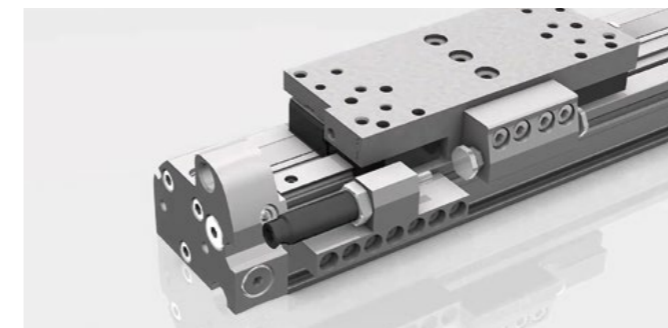

Adjustable stroke limitation can be used to fix a variable stroke length and position over the entire stroke range. Adjustments can be easily made using different shock absorbers without special tools.

We are the guide for handling technology

Turning and driving – no more, no less. And all from a single source. AVENTICS. We not only guide objects and workpieces exactly into their positions with our components and complete solutions – we have also established a leading position for ourselves as providers of handling technology.

Great solutions for small handling

Adequate solutions for practically all conceivable functions in handling technology can be found in AVENTICS comprehensive pneumatics program. Finely-tuned components and elements that perfectly fit together thanks to this consistent product philosophy, combined with sophisticated sensor technology for high precision, make these pneumatic solutions perfect. Modularity and ease of installation of the individual components are always key features of our product offerings in addition to pure functionality. Easy-2-Combine with the online configurator – it pays off!

- Assembly and handling
- Electronics industry
- Semiconductor production

Series	GPC	MSC	MSN	TRR	RCM
Compactness		++	++		++
Load capacity	○	++		++	+
Precision	+	++	++	+	++
Easy-2-Combine	+	++	++		++
Cushioning capacity	+	++		+	++
Stroke range	+	+		++	+
Stroke limitation	○	++		+	++

++ Highly recommended + Recommended ○ Suitable

Serie TRR

The TRR series can realize angles of rotation up to 360° and torques up to 110 Nm and offers adjustable pneumatic cushioning.



TRR

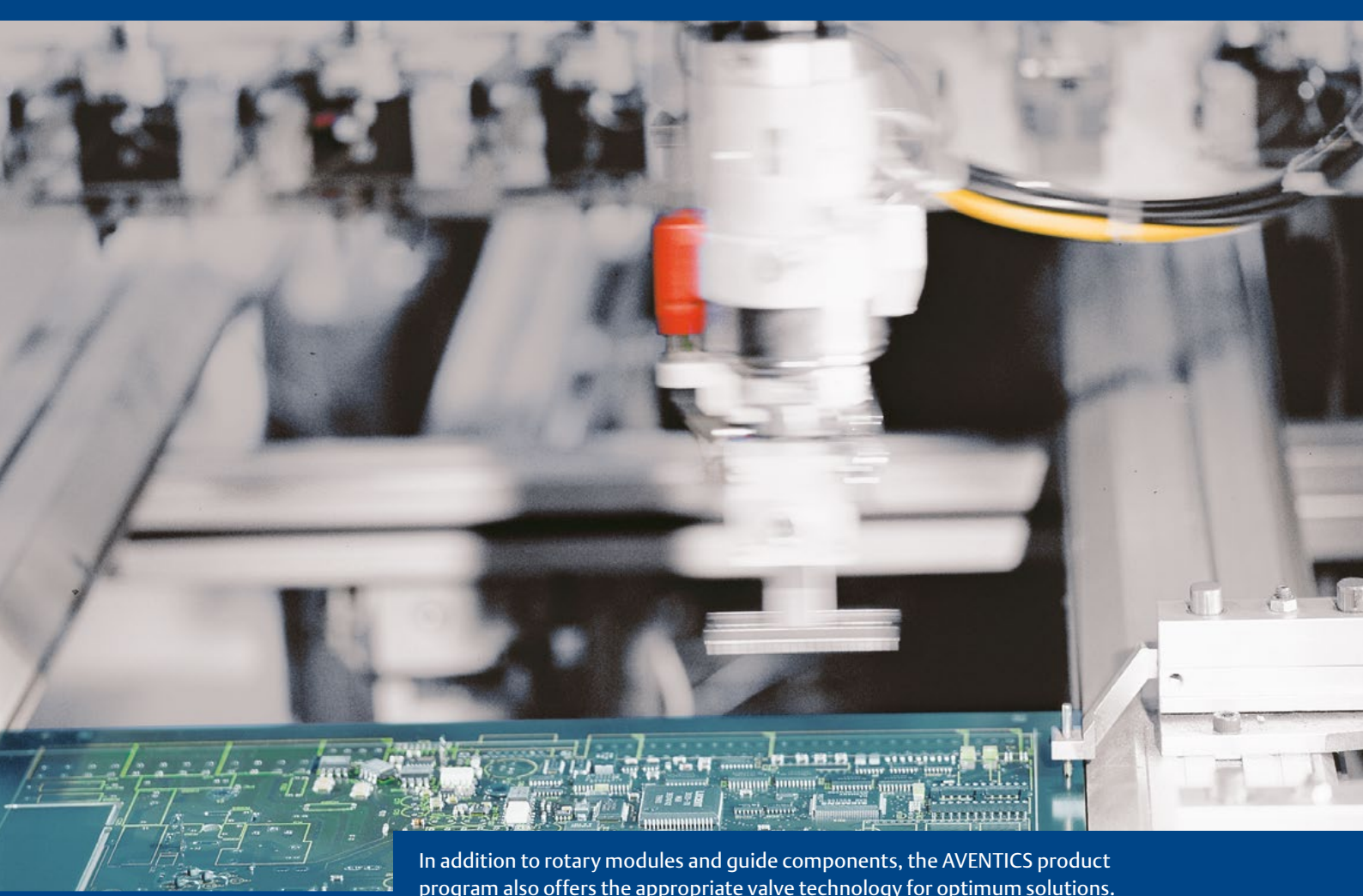

In addition to rotary modules and guide components, the AVENTICS product program also offers the appropriate valve technology for optimum solutions.

GPC series

The GPC series sets itself apart with high side load capacities and torsion protection. The robust, precise drive and guide absorb high torques and transverse forces.



GPC

MSC series

The mini slides from the MSC series have a compact design, require little installation space and reliably ensure the necessary dynamics in the system. They provide maximum rigidity for high torques and loads and feature particularly gentle operation thanks to a unique cushioning system. Air supply options from three sides ensure maximum flexibility when installing the system and variable stroke adjustment enables different strokes within the individual sizes.



MSC

RCM series

Practically all standardized rotary and swivel movements can be performed with the rotary modules in the RCM series. These modules can be installed directly on mini slides and equipped with mechanical grippers.



RCM

MSN series

The mini slides offer a precise guide without play in a slim package. Thanks to an especially wide variety of mounting and air supply options, they can be used in virtually any position and location.

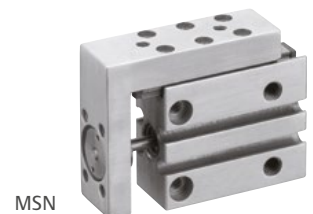

MSN

Overview of variants – basic versions and optional equipment. Handling technology

Mini slides from the new-generation MSC series offer the highest standards paired with highly flexible equipment options.

- 1 | Maximum rigidity: The pre-tensioned guide system without play and one-piece slide table offers maximum stability and reliable precision with minimal tolerance values.
- 2 | Compact and strong: Optimal load bearing capacity, drive force and functionality within a small cross-section enable especially compact machine designs.
- 3 | Maximized payload: The symmetrically operating double-piston system of the guide unit offers maximum load bearing capacity. The MSC can be equipped with one or two pistons.
- 4 | Low-maintenance cushioning: Integrated pneumatic cushioning for the same long service life and the same maintenance intervals as the piston drive. The hydraulic shock absorbers can be replaced without resetting the stroke, which minimizes machine downtimes. The elastic cushioning elements are maintenance-free.
- 5 | Functional design: Sensors, stroke settings and air connections can be installed on both sides. This allows optimal adjustment to the installation situation in the machine.

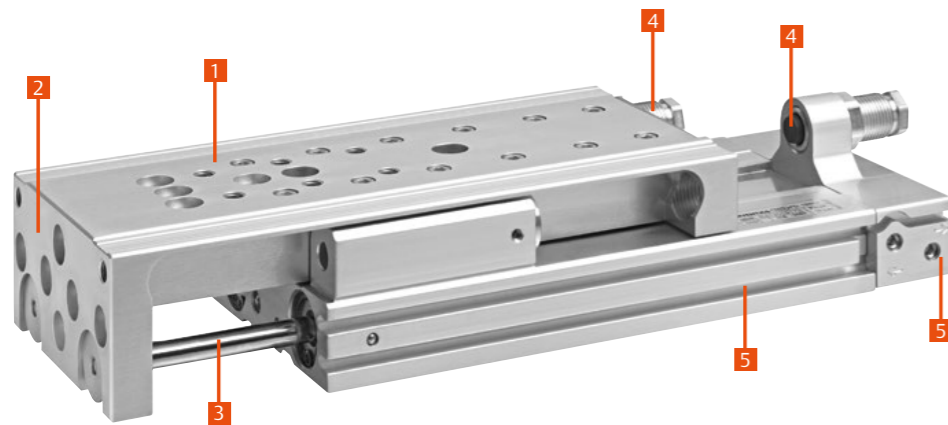

Series	MSN	MSC		GPC-BV	GPC-E	TRR	RCM
Version	with magnetic piston	with magnetic piston		with magnetic piston		with magnetic piston	with magnetic piston
– with elastic cushioning	✓	✓		✓		✓	✓
– with pneumatic cushioning			✓				
 – with hydraulic cushioning		✓			✓	✓	✓
 Number of pistons	1	1 or 2	2	1	1	2	2
 Ball rail guide	✓	✓	✓			Rack	Rack
 High-performance ball rail guide		✓	✓				
 Slide bearing				✓	✓		
 Ball bearing				✓	✓		
Easy-2-Combine interface	✓	✓	✓	✓	✓	✓	✓
Piston diameter	6 - 16 mm	8 - 25 mm		10 - 100 mm	12 - 20 mm	32 - 100 mm	6 - 25 mm
Stroke range	5 - 30 mm	10 - 200 mm		10 - 200 mm	25 - 150 mm		

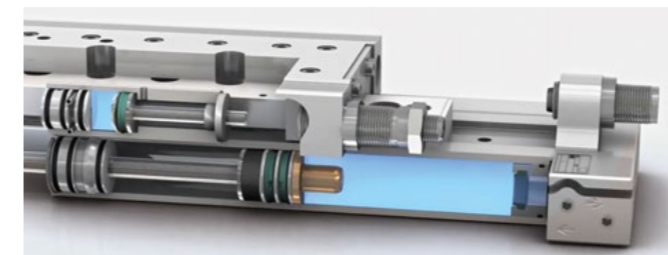

The guided slide units offer several cushioning options. Pneumatic cushioning provides a new, unique option that, in addition to the elastic cushioning elements and hydraulic shock absorbers, ensures especially gentle operation.



Depending on the mounting situation, end plates with different air connections can be used. Connections from three sides or in the compact version with connections only at the rear.

Special cylinders for special applications and customized solutions

When you need a highly specialized solution: tailor-made cylinders and components

Our pneumatics experts develop customized solutions with functions that are tailored to specific applications. This can include newly designed cylinders or slightly but vitally modified components from the standard cylinder program. Contact our experts! They have know-how from decades of individual design and development work. If there's an individual solution for your application, we'll find it.

- Modification of standard components
- Combining different functions in a single product
- Product development with additional specifications

Rely on our competence from the outset! From the first discussion, the search for a solution, building of prototypes through the test phases, right up to series production of your individual pneumatics solution.

Cylinder with modified piston rods, specially designed profiles, materials and additional functions





All bellow actuators permit high forces in small installation spaces. They operate practically without wear or the need for maintenance.

Bellow actuators – BCP, BCC, BCR, BRB series

We offer four series of bellow actuators. The various designs, equipment, and materials mean that each series is predestined for specific tasks.



BCR



BCP

BCC

BRB

SWN series screw-in cylinders

The cylinders in the SWN series can be easily installed without further accessories. Thanks to a thread integrated directly into the cylinder body, they can be installed in their working environment without taking up space.



SWN

RDC series flexible diaphragm cylinders

Thanks to their low friction, the RDC cylinders can be actuated at low pressure. These cylinders permit precise balancing of forces, particularly in finely-tuned systems.



RDC

The right accessories for all operating conditions and machine environments

They are unimposing but essential. They simply belong there: the right accessories for the job. We have always attached great importance to having an extensive program of accessories in order to ideally meet the needs of the most varied applications.

We've thought of everything!

Accessories are an integral part of the scope of supply and have the same high quality as the entire product range. Practical experience from decades of user-oriented work has also gone into perfecting product accessories. This is a precondition and guarantee for efficient and generally trouble-free continuous operation of machines and systems.

- Exactly matched to the product program
- Mountings complying with ISO standard
- Best material and manufacturing quality
- Delivery units configured exactly to the product

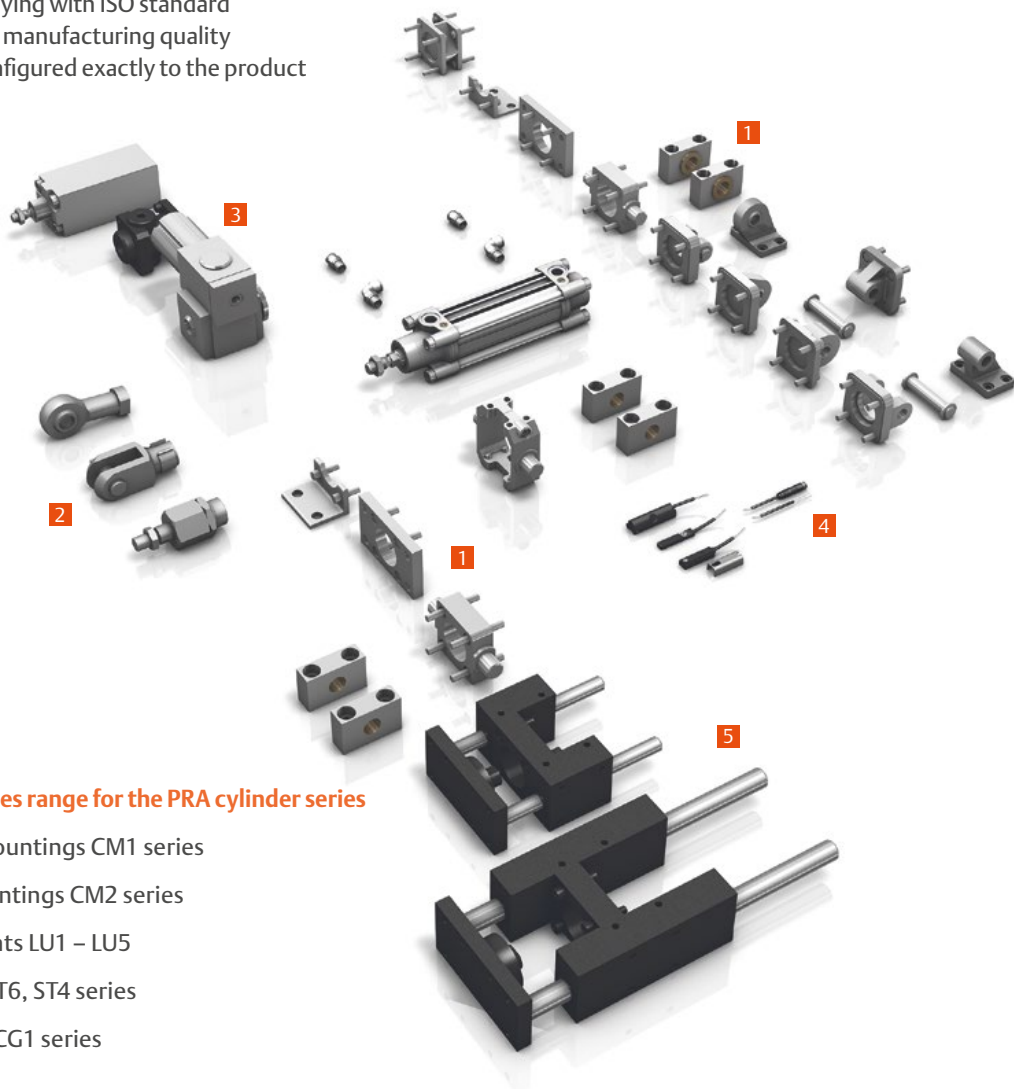

Example: accessories range for the PRA cylinder series

- 1 | Cylinder rod mountings CM1 series
- 2 | Piston rod mountings CM2 series
- 3 | Locking elements LU1 – LU5
- 4 | Sensors SM6, ST6, ST4 series
- 5 | Function units CG1 series



Whether it's a secure cylinder mounting, simple piston rod nut, or plain sensor bracket – the importance of these small parts only becomes apparent when they are missing or don't fit. That is no problem for Emerson customers.

Cylinder rod mountings CM1 series

Bolts, flange mountings, foot mountings, clevis mountings, rear eyes, bearing blocks, nuts for cylinder rod mountings, trunnion mountings, intermediate flanges.



Piston rod mountings CM2 series

Compensating couplings, rod clevises, ball eye rod ends, piston rod extensions, nuts for piston rod mountings.



Function units CG1 series



Shock absorbers SA1, SA2, 370 series



Holding, locking, braking – non-stop machine safety

LU6 locking unit/dynamic brake

The LU6 is a mechanical locking unit/brake for piston rods in pneumatic cylinders according to ISO 15552 or comparable round bars. It is a safety component in accordance with the Machinery Directive 2006/42/EC (CE mark) and can be used in safety-relevant controls. The LU6 locking unit for D32-100 has been tested by the German Institute for Occupational Safety and Health (IFA) and certified as a pneumatic braking/holding unit with safety function as per DIN ISO 13849.

- Prevention of hazardous movement (cat. 1 up to max. PL c, “proven component”)
- Secure hold in upper end position through clamping and one-sided pressurization (cat. 4 up to max. PL e)
- Interruption of a hazardous movement (emergency stop)
- High B_{10d} -dynamic braking values: 2 million cycles
- High B_{10d} -static holding values: 5 million cycles
- Optional function query on LU6 by IN1 sensor



Modular scraper for series PRA/TRB and ITS cylinders

Five scrapers modules are available for each of the cylinder series. They are available separately as spare parts with fully installed seals and bushings and can be exchanged at any time, quickly and easily, without removing the cylinder.



More flexibility, better sealing quality, longer service life, lower costs

- For series PRA and TRB: cylinder versions with a specific selection of scrapers (optional)
- For series ITS: choice of scrapers as a standard feature

You are free to decide which scrapers mean the greatest benefits for your application and industry. You can even implement a different scraper model with the same cylinder if your needs change.

- Effective scraping, longer service life
- Protected piston rod seal
- Easy exchange, low-maintenance
- Application-specific scraper technology
- Excellent flexibility thanks to a modular concept

Modular sealing system – even more process efficiency



Whether it's just loose dirt or sticky fluids, or stubborn hard materials that cling to the piston rod – scrapers on the modular sealing system adapt to your application, no matter the requirements.

Holding unit HU1

Holds piston rods using spring force. Mounting to cylinder via a corresponding adapter. Holding cartridge can be exchanged in case of wear.



Locking unit LU1 – LU5

Eccentric movement holds the piston rod in any position. Flange mounting to cylinder.

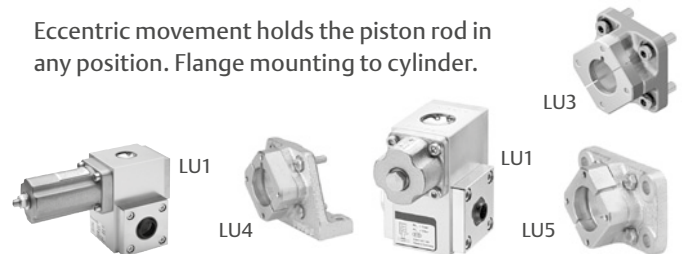

Cylinders	Series PRA/TRB, Ø 32 to Ø 125 mm					Series ITS, Ø 160 to Ø 320 mm				
	Modular scrapers	NBR-PEE	NBR-PTFE	FKM-PTFE	PUR/metal	FKM/metal	NBR	FKM	PUR/metal	FKM/metal
Seal	NBR	NBR	FKM	PUR	FKM	NBR	FKM	PUR	FKM	PTFE
Scraper 1	PEE	PTFE	PTFE	FKM	FKM	NBR	FKM	PUR	FKM	PTFE
Scraper 2				metal	metal			metal	metal	
Temperature resistance	-20 to +80°C	-20 to +80°C	-10 to +150°C	-20 to +80°C	-10 to +150°C	-20 to +80°C	-10 to +150°C	-40 to +80°C	-10 to +150°C	-10 to +150°C
General industry				■		■	■	■		
Woodworking industry				■	■			■	■	
Steel industry					■				■	
Paper/printing industry	■					■	■			
Textile industry, food industry, chemical industry	■	■	■							■

NBR = acrylonitrile butadiene rubber, PTFE = polytetrafluoroethylene, FKM = fluorocarbon rubber, PU = polyurethane, PEE = polyester elastomer, Metall = brass

Our sensor technology for pneumatic cylinders

Matching sensors for all cylinders including accessories

In addition to high-precision measurements, excellent flexibility during mounting and adjustment are also required to meet varied demands.

- Sensors with cable connection, push-in fitting, M8 plug with knurled screw, contactless, in an ATEX version
- Sensor solutions for all AVENTICS cylinder series
- Mountings, cable holders, connecting cables, angled connector



ST4 /ST4-2P series

Sensors for 4-mm slots offer high-tech in the tightest space and are always the right choice when every millimeter counts – ideal for pneumatic actuators in small handling.



SC4 series

The SC4 is suitable for applications with pneumatic cylinders with a C-slot. Its short housing and connection line rotated by 90° make it ideal for use in tight spaces and with short-stroke cylinders. Thanks to a short, exact switching range, the SC4 is also a perfect fit for the AVENTICS UPG gripper series.



ST6 series

Universal sensors for standardized 6-mm slots: their optimized form permits flush fitting in the existing slots and even spacesaving integration in any machine environment using sensor mountings.



SM6 series

With four versions, series SM6 distance measuring sensors flexibly cover any required measurement range. They are easy to assemble and can be adjusted as needed within the maximum measurement range.

































SM6-AL series

The SM6-AL analog distance measuring sensor also enables high-resolution distance measurement across the entire range of 107 to 1,007 millimeters. The distance measuring sensor is thus ideal for the continuous recording of piston movements in pneumatic cylinders. A robust, chemical-resistant aluminum housing, as well as a cable sleeve support, guarantee a long sensor service life and reduce maintenance costs.



For further information on these or any other AVENTICS product, visit Emerson.com

Overview of the basic compatibility between the sensor series and cylinder series

Recommended sensors for on-cylinder mounting: - via the nut: ● - via sensor mounting: ○	  ST4 series ST4-2P series	  SC4 series	  ST6 series	  ST9 series	  SM6 series	  SM6-AL series	  SN2 series
MNI (ISO)  ICM (ISO) 	○		○		○		○
CSL 	○		○				○
RPC 			○				
CCI/KPZ (ISO) 			●		●		
SSI 	●	●	●		●		
KHZ 			○	●			
PRA/CVI (ISO) 	●	●	●		●	○	○
TRB/CVI (ISO) 			○		○		○
ITS (ISO) 			○		○	○	○
CCL-IS/CCL-IC (ISO) 			○				
RTC 	●		○			○	
GSU/CKP 	●						
GPC 	●	●	●		●		
MSC 	●	●					
MSN 	●	●					
RCM 	●						

The crucial difference: all-round support until everything is running

How to find the perfect cylinder for your application

Simply enter the key performance parameters for your new cylinder to get an overview of all possible cylinders. Additional filters and comparison analyses narrow down your results. After you have made a decision, you are forwarded to the directly linked configuration program.

- Application data input: stroke, mass load, time, load movement direction and pitch angle, cycles per hour, additional detailed data as an option – intuitive navigation with help information.
- As a result, all possible cylinder series are listed with the key basic data and additional comparison values – weight, speed, air consumption, etc.
- The selection can be refined according to the desired specifications via the comprehensive filter menu.





















Product series	Drive	Cushioning	Guide	Weight (kg)	Air Consumption (liters/cycle)
PRLA	32	1-Elastic	000 Plain InternalGuiding	0.72	1.08
PRLA	32	1-Elastic	L01 Plain LinearGuide	0.72	1.08
PRLA	32	2-Pneumatic	000 Plain InternalGuiding	0.72	1.08
PRLA	32	2-Pneumatic	L01 Plain LinearGuide	0.72	1.08
TRB	32	1-Elastic	000 Plain InternalGuiding	0.70	1.05
TRB	32	1-Elastic	L01 Plain LinearGuide	0.70	1.05
TRB	32	2-Pneumatic	000 Plain InternalGuiding	0.70	1.05
TRB	32	2-Pneumatic	L01 Plain LinearGuide	0.70	1.05

The easy way for precise cushioning adjustment













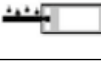
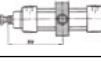



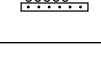

So far an optimum end cushioning adjustment requires experience, a certain feeling and sometimes patience. Today, you can count on the reliable support of sensor electronics. The adjustment of end cushioning is easy and quick, ensuring the correct settings. After the sensor is fixed on the cylinder and switched on, all functions can be read from the large LED display and cushioning adjustment can be effected precisely. In addition, the optional AVENTICS app provides information about piston speed and the cushioning characteristics graphically.



Glossary

Symbol	Designation
	Piston rod cylinder without magnet, with elastic cushioning
	Piston rod cylinder with magnet, with elastic cushioning
	Piston rod cylinder without magnet, with pneumatic cushioning
	Piston rod cylinder with magnet, with pneumatic cushioning
	Piston rod cylinder without magnet, non-rotating, with front plate
	Piston rod cylinder with magnet, non-rotating, with front plate
	Rodless cylinder with magnet, with hydraulic cushioning
	Rodless cylinder with magnet, with pneumatic cushioning
	Heat-resistant versions for use up to the specified ambient temperature in °C
ISO	Versions comply with the specified installation standards
	Version in stainless steel, corrosion-resistant steel x5CrNi 18 – 10, x5CrNi 18 – 9, x17CrNi 16 – 2
	Cylinder with compressed air supply on one side only, return to home position with tension springs
	Piston rod length can be configured as needed within the technically feasible range
	Piston rod guided through cover and bottom, mounting on both ends
	Versions are suitable for ATEX applications (zones and corresponding categories)
	Grease used as a lubricant is suitable for use in the food industry acc. to NSF-H1
	Cylinder pistons have a special form with an oval cross-section
	Number of pistons for slide operation, MSC mini slides, can be operated with 1 or 2 pistons as desired
	Rotated end covers, clean pipe-cover connection thanks to optimized rolling geometry
	Elastic cushioning elements, mainly polymers, to absorb stopping energy in end position
	Stroke length can be configured as needed within the entire stroke range
	Smooth-running versions

Glossary

Symbol	Designation
	Piston rods available with internal or external thread
	Cylinders can be individually equipped with the modular sealing system
	Cylinder with improved corrosion resistance
	Cylinder can also be mounted using a trunnion mounting
	For safe machine applications, cylinder is suitable for use as a mechanical holding and brake unit
	For safe machine applications, cylinder is suitable for use as a mechanical holding and locking unit
	Cylinder is also available as a preassembled working unit with valve and tubing
	Adjustable cushioning on the cylinder can be adjusted as needed.
	Pneumatic cushioning adjusted at factory, optimized for standard applications
	Slide is guided by a ball rail
	High-performance ball rail guide with optimized precision, rigidity and load capacity
	Stroke can be limited using shock absorbers situated as needed across the cylinder stroke range
	Cylinders have an Easy-2-Combine interface, mounting without additional transition plates
	Hydraulic shock absorber to reduce the stopping energy of the cylinder piston
	Cylinder suitable for sensors for continuous distance measurement of the piston position
	Slide guide based on a special slide bearing
	Slide guide based on a special ball bearing
	4 mm C-slot integrated in cylinder profile for all 4 mm sensors in the ST4, ST4-2P series
	6 mm T-slot integrated in cylinder profile for all 6 mm sensors in the ST6, SM6 series
	Dovetail slot integrated in cylinder profile for ST9 series sensors

The homepage for non-stop service

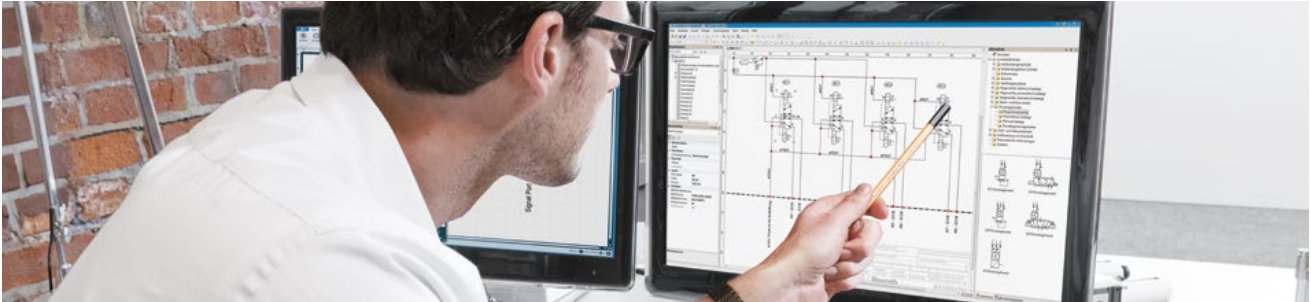

AVENTICS' Engineering Tools bundle the entire pneumatics range and comprehensive expertise at one convenient location – www.engineering-tools.com

CAD



Objects can be issued here directly as a CAD file in various formats, as a PDF file, or for further configuration in our customers' software.

Configurators



To create customized products matching their individual requirements, customers can set their parameters in the configuration program, which then presents a product tailored to their specifications.

Calculation programs



With transparent calculations, our customers can determine the size or durability needed for their products and can even keep an eye on energy consumption.

Circuit diagram software



With the Scheme Editor, our customers can quickly and easily create circuit diagrams that are based on their components and linked their your catalog selection.

Cross Reference Tool



This tool shows our customers the right alternatives to competitor products from within the AVENTICS catalog.

CylinderFinder



This free online tool helps our customers find the right cylinder for their application with just a few clicks.

Sales Partner Portal



The Sales Partner Portal establishes a direct connection between AVENTICS and our sales partners and speeds up communication. It also contains a great deal of valuable information.



Smart shopping for pneumatics professionals



In the new Online Shop, you can easily, quickly and securely order your pneumatics products – www.pneumatics-shop.com
Your advantages:

- Intelligent search and filter functions
- Spare parts and accessories available for every product
- Track your orders online
- Transparent pricing

Simply register with your e-mail address, password and order directly

Cylinders		
Diameter		Series
6 – 16 mm		SWN
10 – 25 mm		MNI ISO 6432
8 – 32 mm		ICM ISO 6432
16 – 25 mm		CSL ISO 6432
32 – 63 mm		RPC
32 - 100 mm		ICS
16 – 100 mm		CCI ISO 21287
16 – 100 mm		CCL-IC ISO 21287
12 – 100 mm		SSI ISO 15524
8 – 100 mm		KHZ
16 – 100 mm		KPZ NFE 49004
32 – 125 mm		PRA ISO 15552
160 – 320 mm		ITS ISO 15552
25 - 125 mm		CCL-IS ISO 15552
32 – 125 mm		TRB ISO 15552
52.5 – 115 mm		RDC

Cylinders/handling technology		
Diameter		Series
32 – 125 mm		CVI ISO 15552
16 – 80 mm		RTC
16 – 32 mm		CKP
16 – 25 mm		GSU
90 – 640 mm		BCP
80 – 435 mm		BCC
442 – 950 mm		BCR
60 – 173 mm		BRB
6 – 16 mm		MSN
8 – 25 mm		MSC
10 – 100 mm		GPC
Torque 0.17 – 6,5 Nm		RCM
Torque 4.5 – 110 Nm		TRR

Sturdy and reliable. The right cylinder solution for every application – perfectly matched to each other



Visit us: [Emerson.com/AVENTICS](https://www.emerson.com/AVENTICS)

Your local contact: [Emerson.com/contactus](https://www.emerson.com/contactus)



[Emerson.com](https://www.emerson.com)



[Facebook.com/EmersonAutomationSolutions](https://www.facebook.com/EmersonAutomationSolutions)



[LinkedIn.com/company/Emerson-Automation-Solutions](https://www.linkedin.com/company/Emerson-Automation-Solutions)



[Twitter.com/EMR_Automation](https://twitter.com/EMR_Automation)

The Emerson logo is a trademark and service mark of Emerson Electric Co. AVENTICS is a registered trademark of one of the Emerson family of companies. All other marks are the property of their respective owners. © 2021 Emerson Electric Co. All rights reserved.
BR000078ENUS-01_04-21



EMERSON™

CONSIDER IT SOLVED™